

BSC27-N2201C

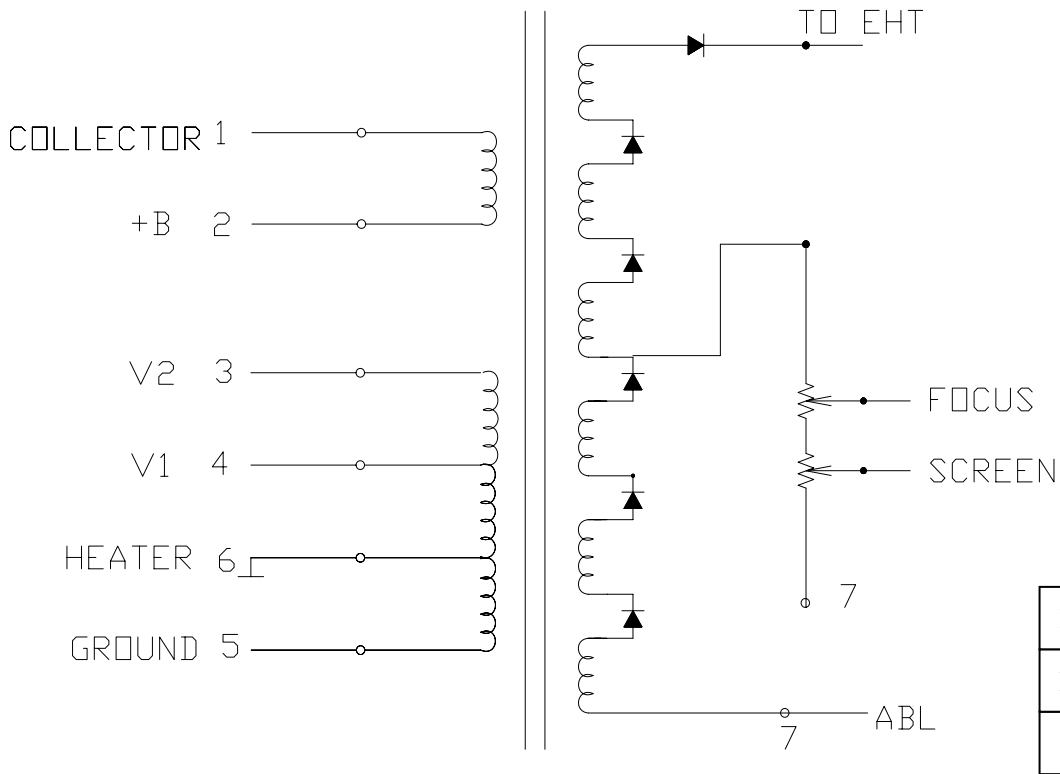

HV	26.4 KV
FV	5.5-10.6KV
SV	0-1150V

BSC28-0615A

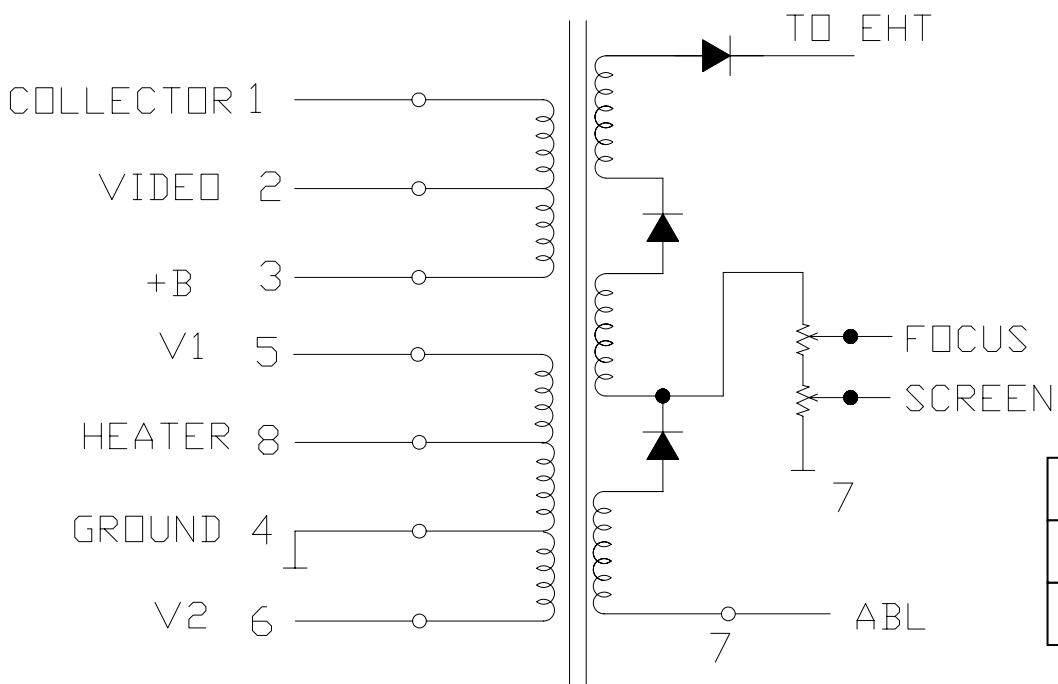

HV	24KV
FV	3.2-6KV
SV	20-800V

BSC28-0910S

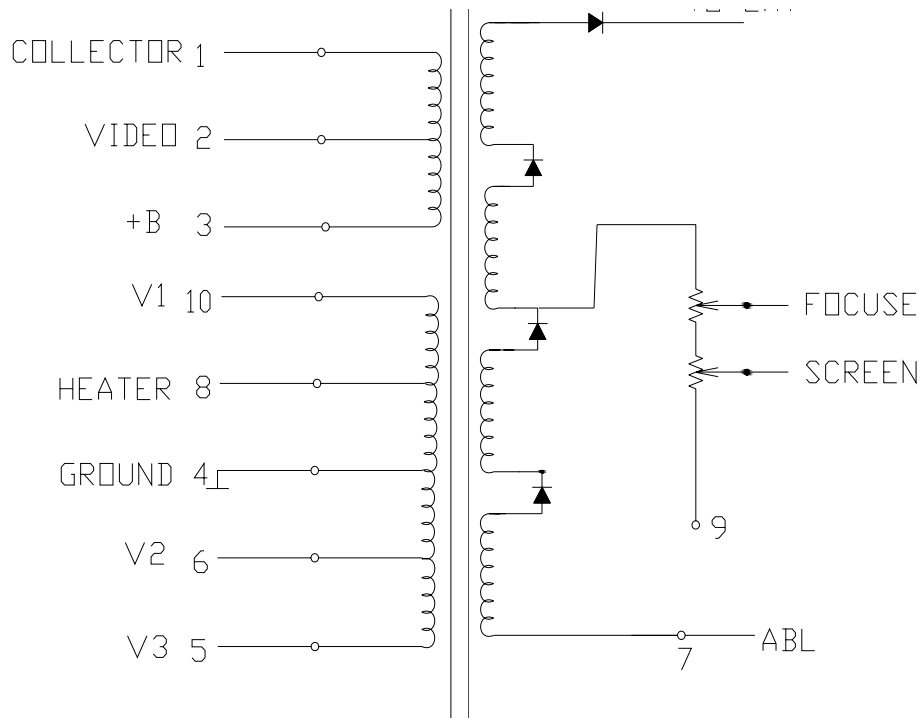

HV	27.5KV
FV	3.8-9.2KV
SV	10-980V

BSC28-1202

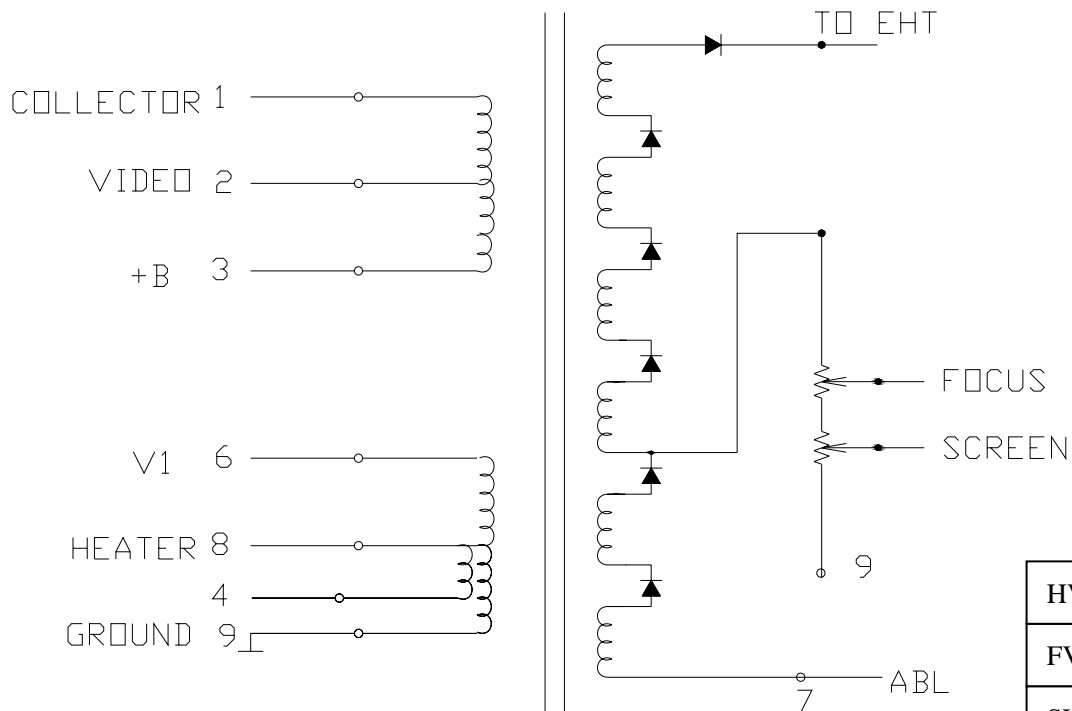

HV	28KV
FV	6.1-10KV
SV	150-1000V

BSC28-5308

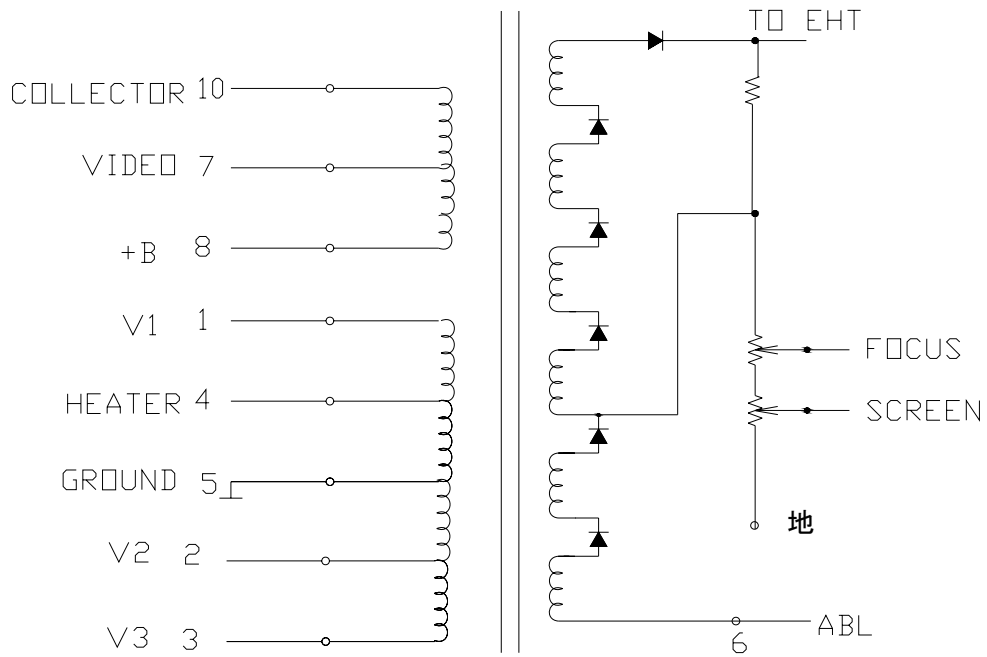

HV	27 KV
FV	3.9-8KV
SV	0-1050V

BSC29-0126

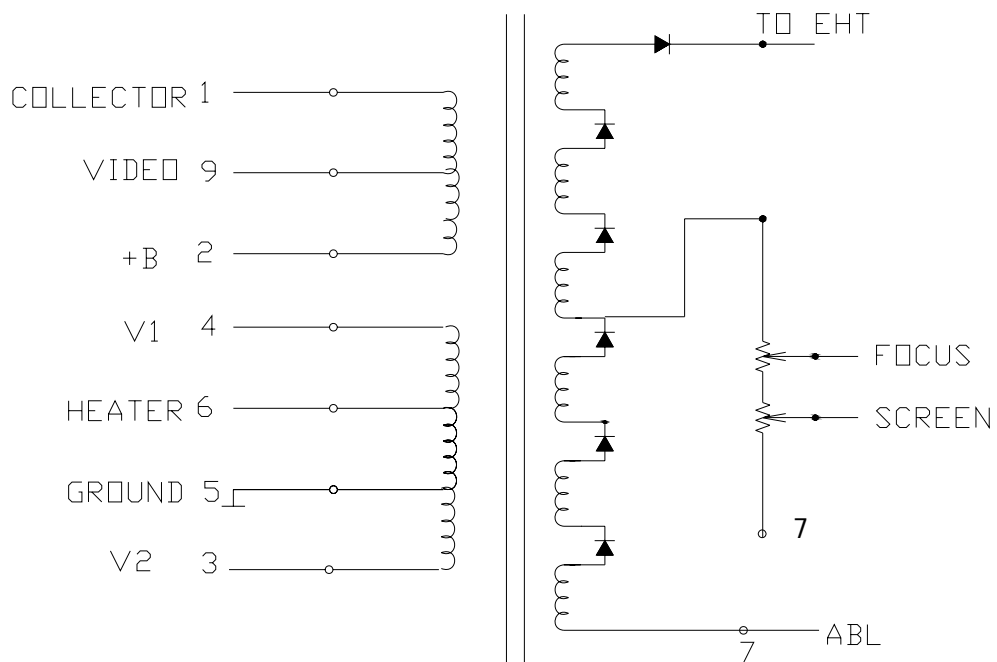

HV	26.3 KV
FV	4.2-7.9KV
SV	100-980V

BSC29-0501

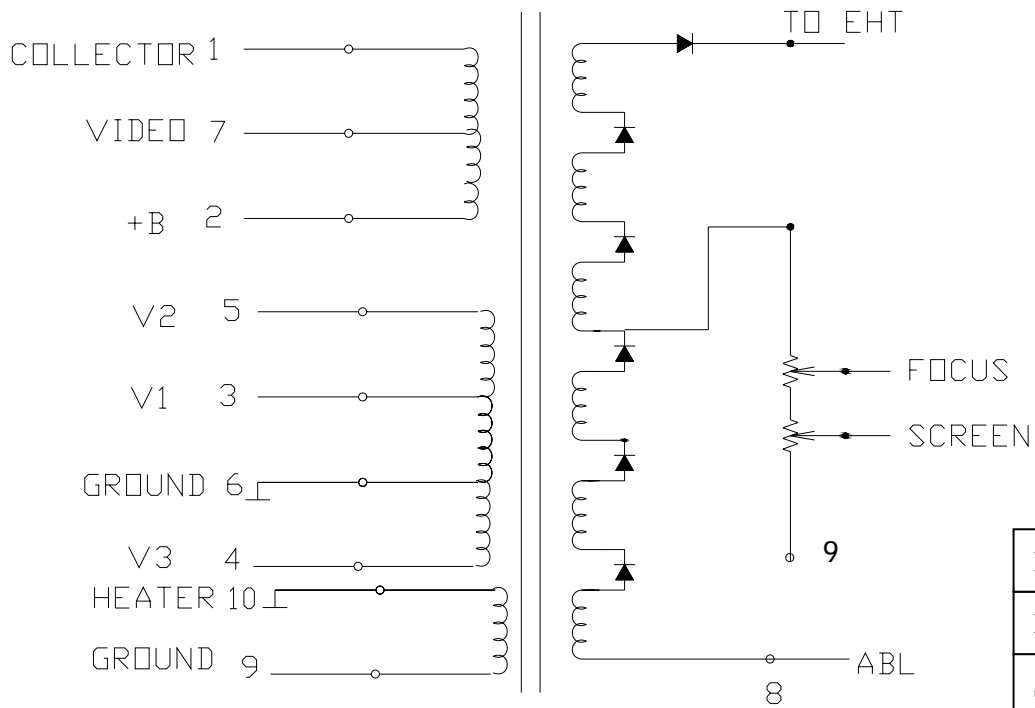

HV	27.1KV
FV	3.3-6.5KV
SV	50-850V

BSC29-1407S

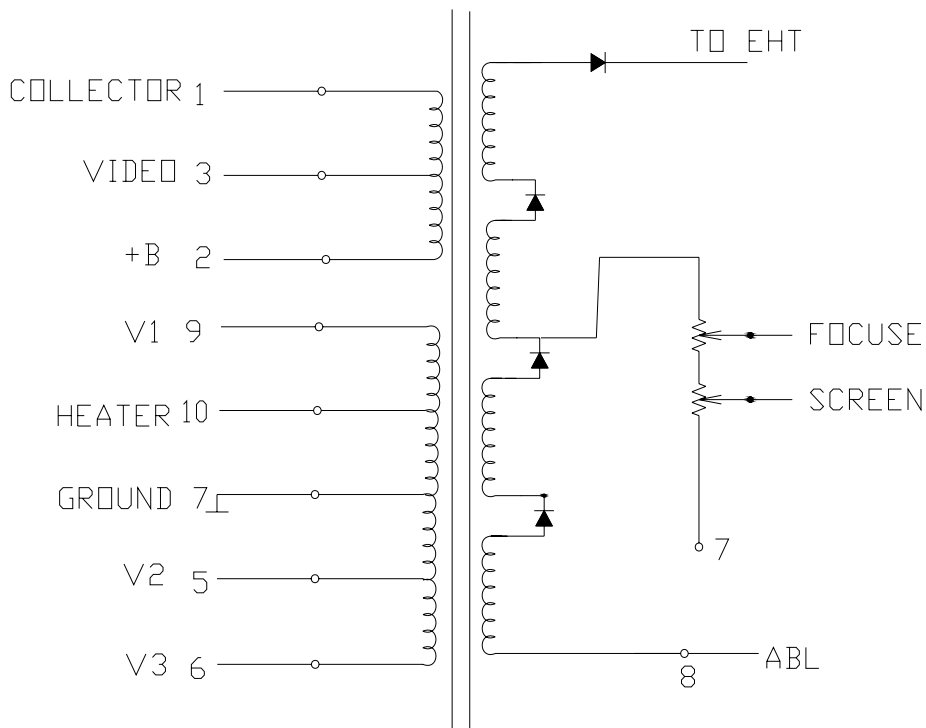

HV	27.2KV
FV	3.5-7.8 KV
SV	60-1050V

BSC29-3718

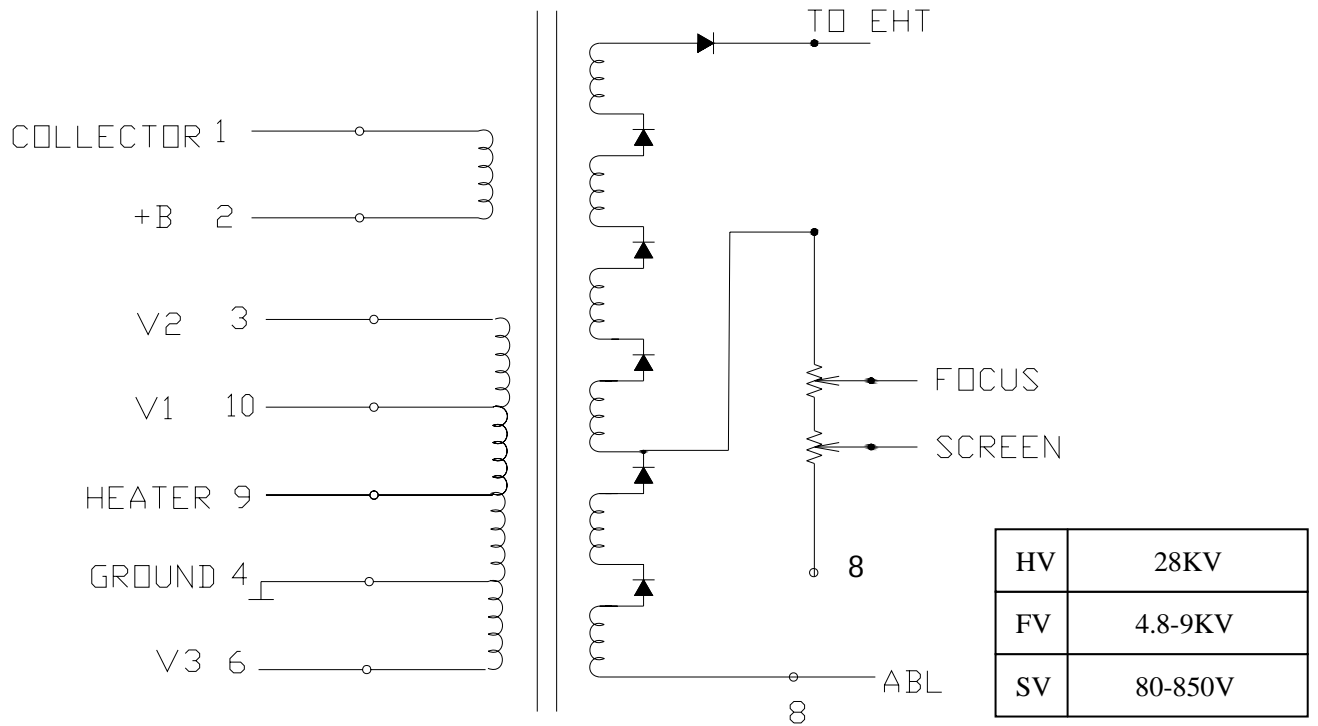

HR6067

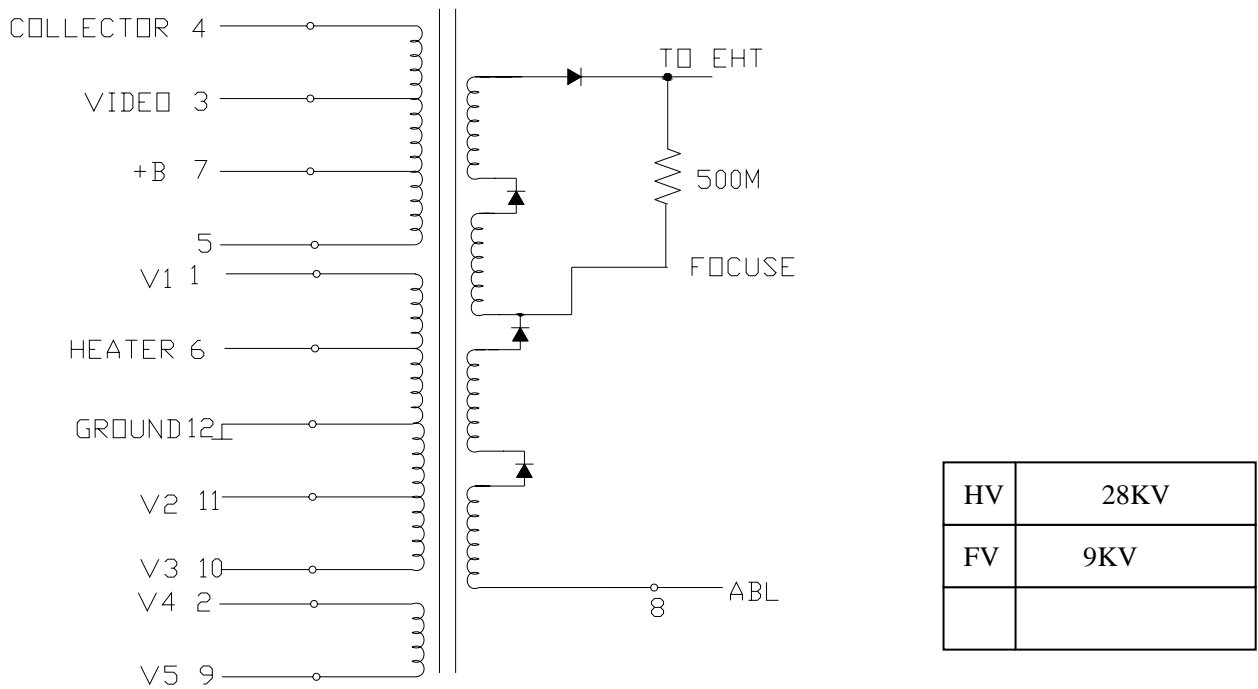

HR6140

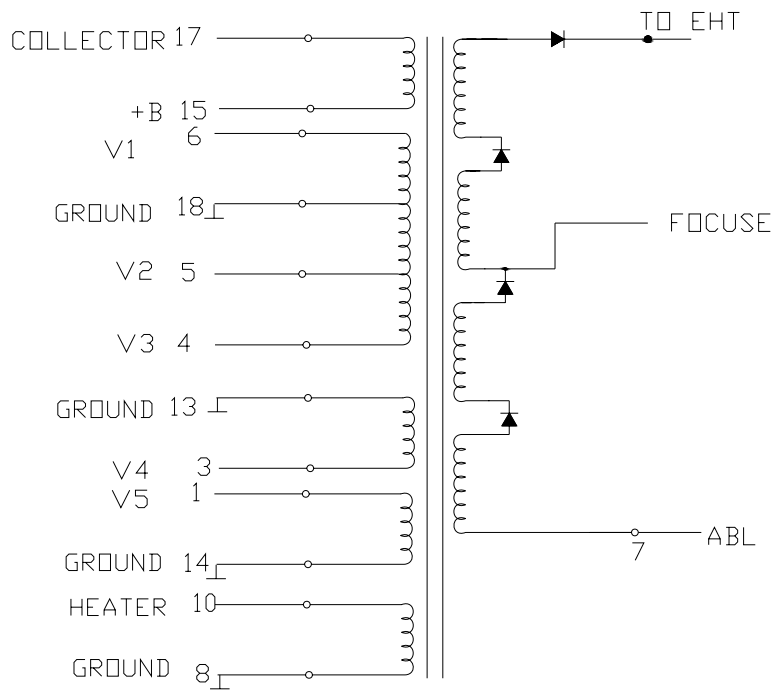

HV	23.6 KV
FV	7 KV

HR6160

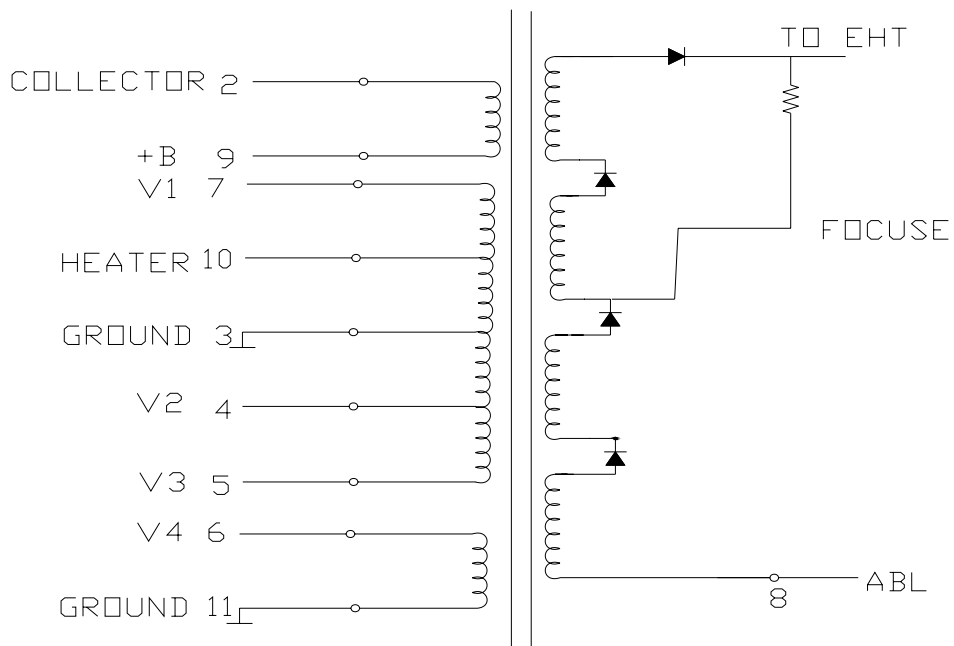

HV	23.7KV
FV	8.8KV

HR6203

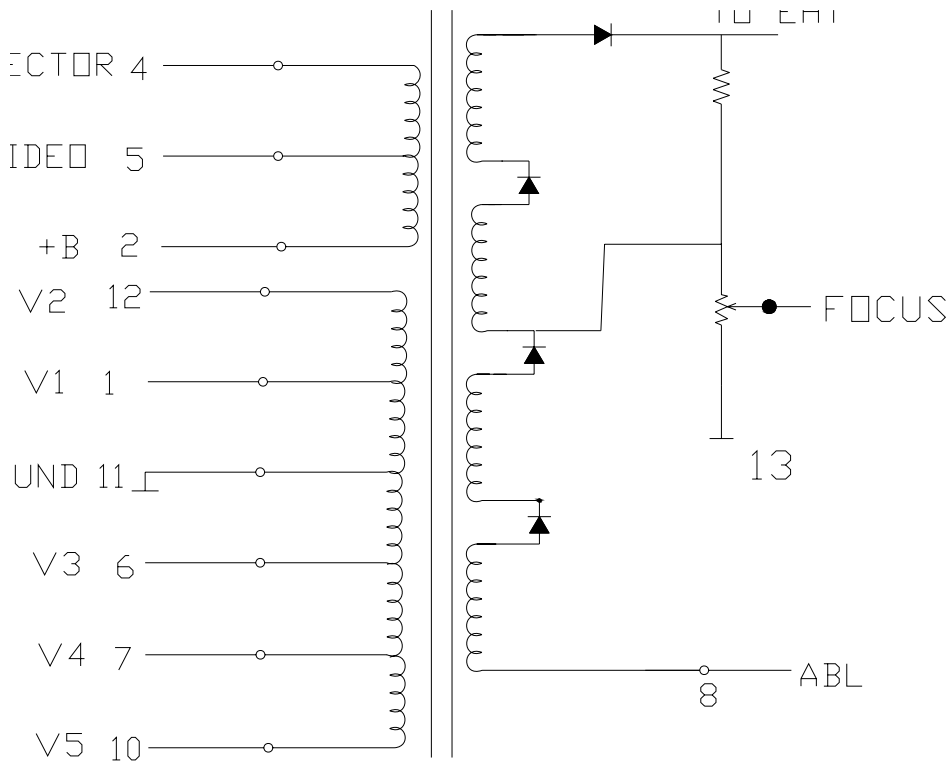

HV	26.7 KV
FV	5-9KV

HR6213

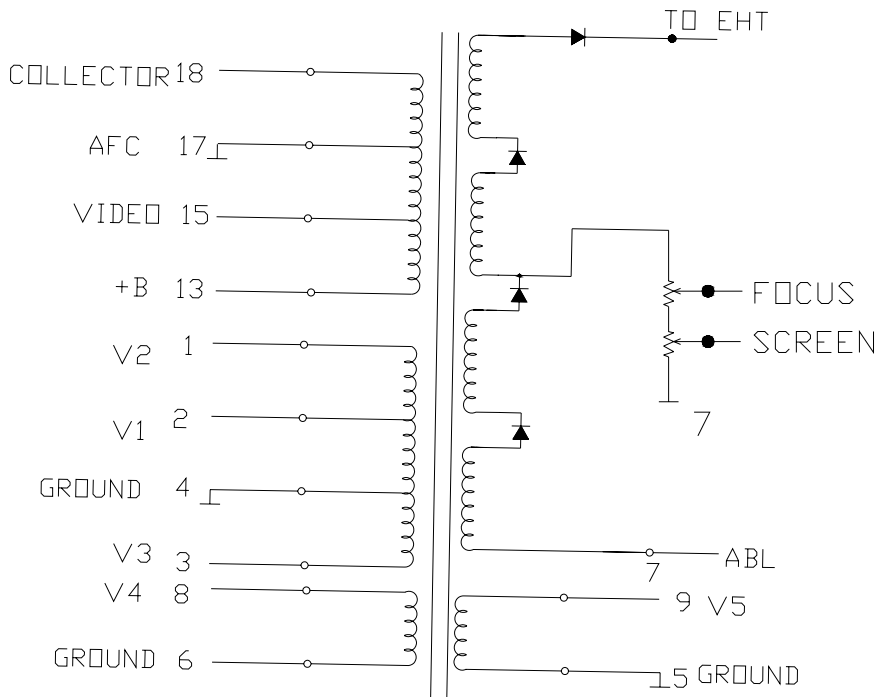

HV	21.5KV
FV	3.9-6.8KV
SV	0-1150V

HR6216

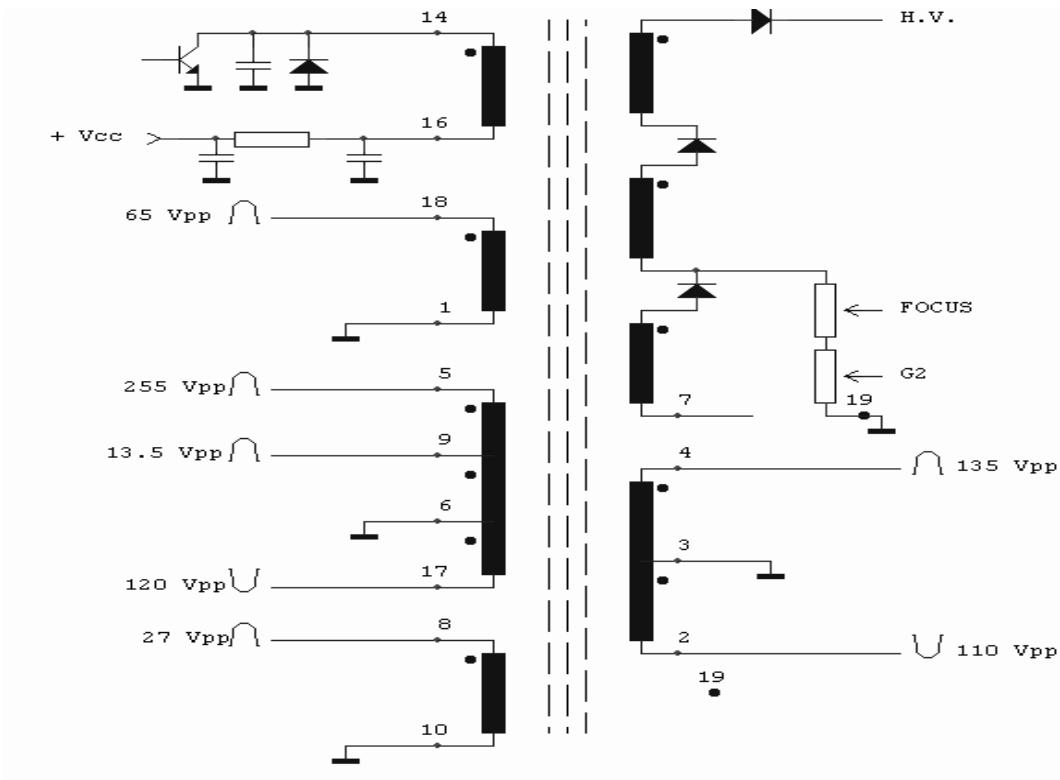

HV	25.9KV
FV	4.9-9KV
SV	50-900V

HR6256

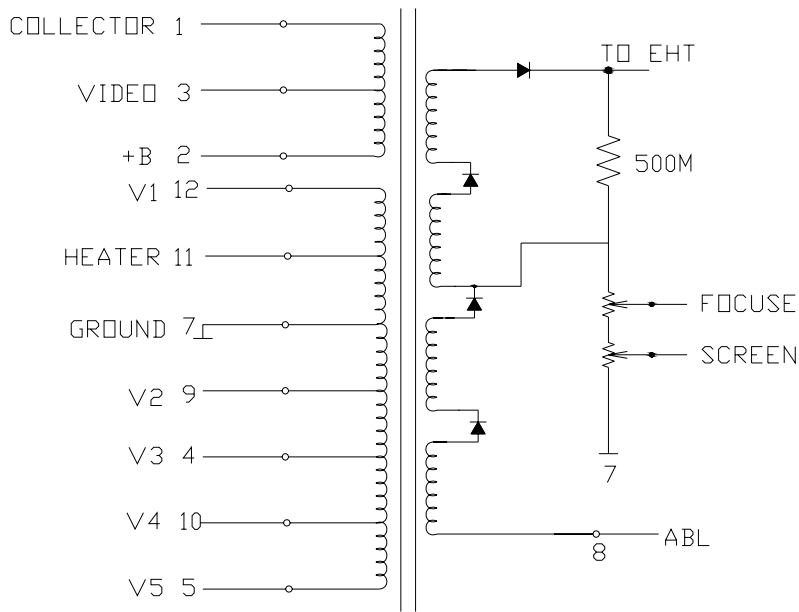

HV	24.9KV
FV	4.4-8KV
SV	50-990V

HR6260

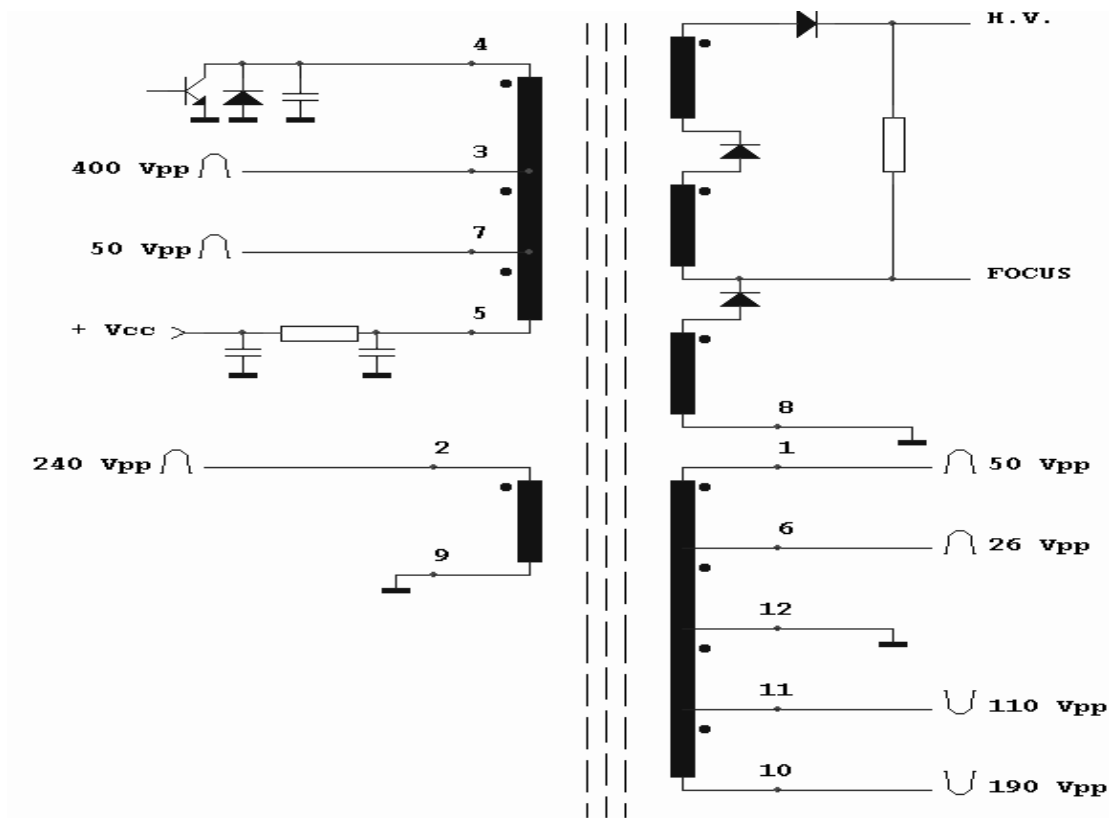

HV	28.7 KV
FV	10KV

HR6284

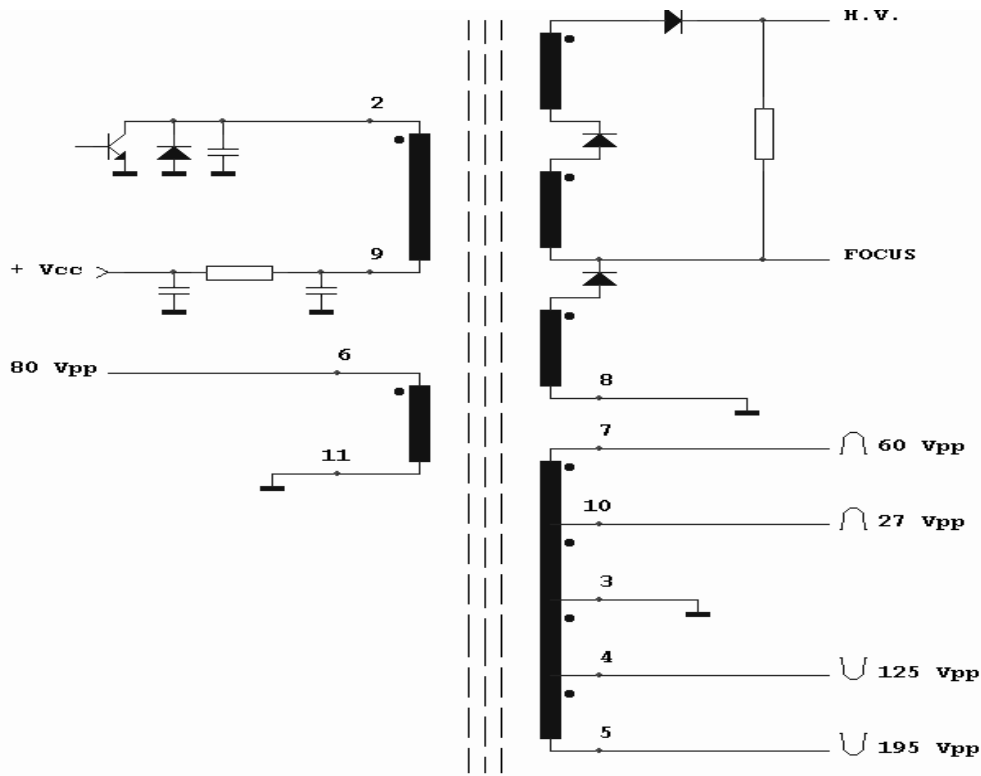

HV	27.1 KV
FV	9.2KV

HR6354

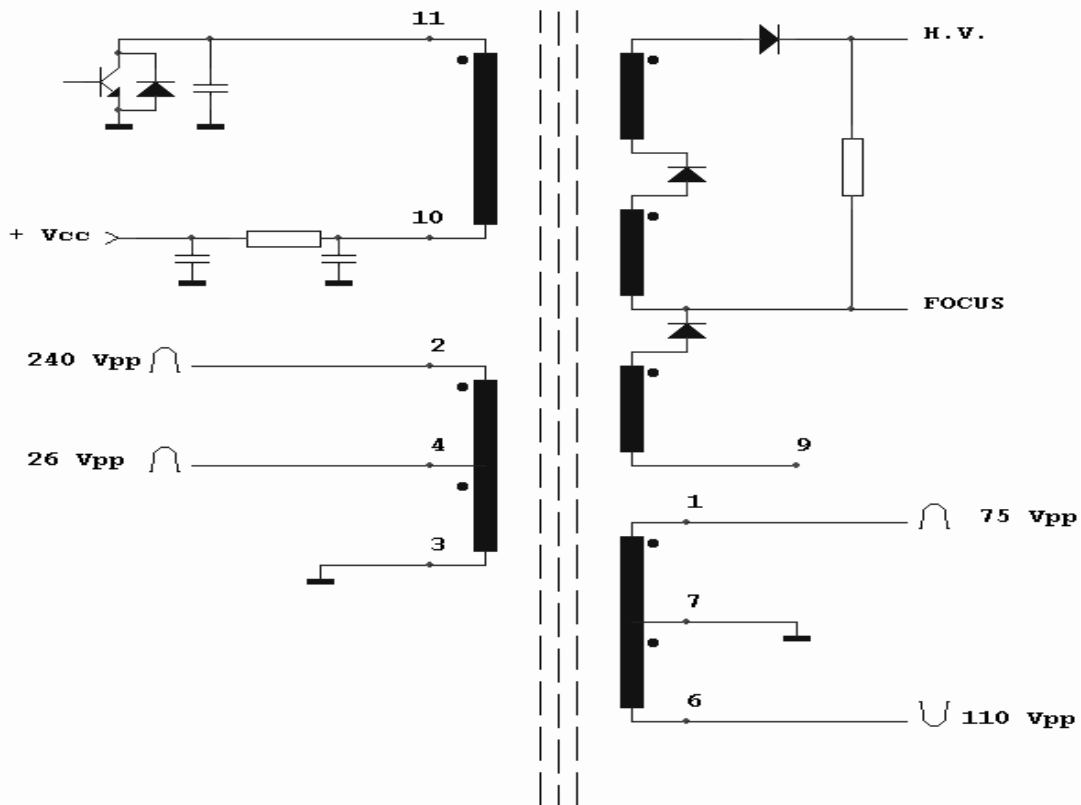

HV	24.7KV
FV	7.9KV

HR6372

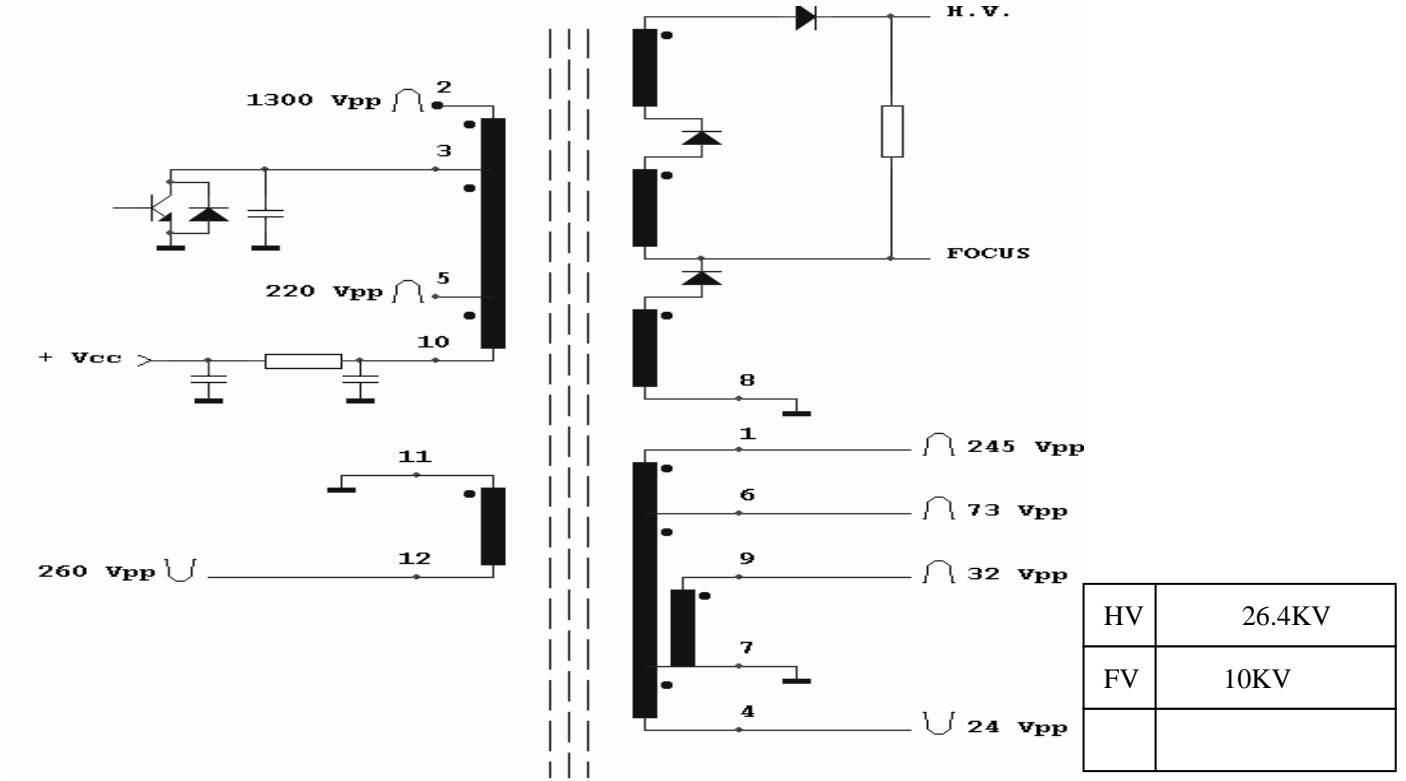

HR6475

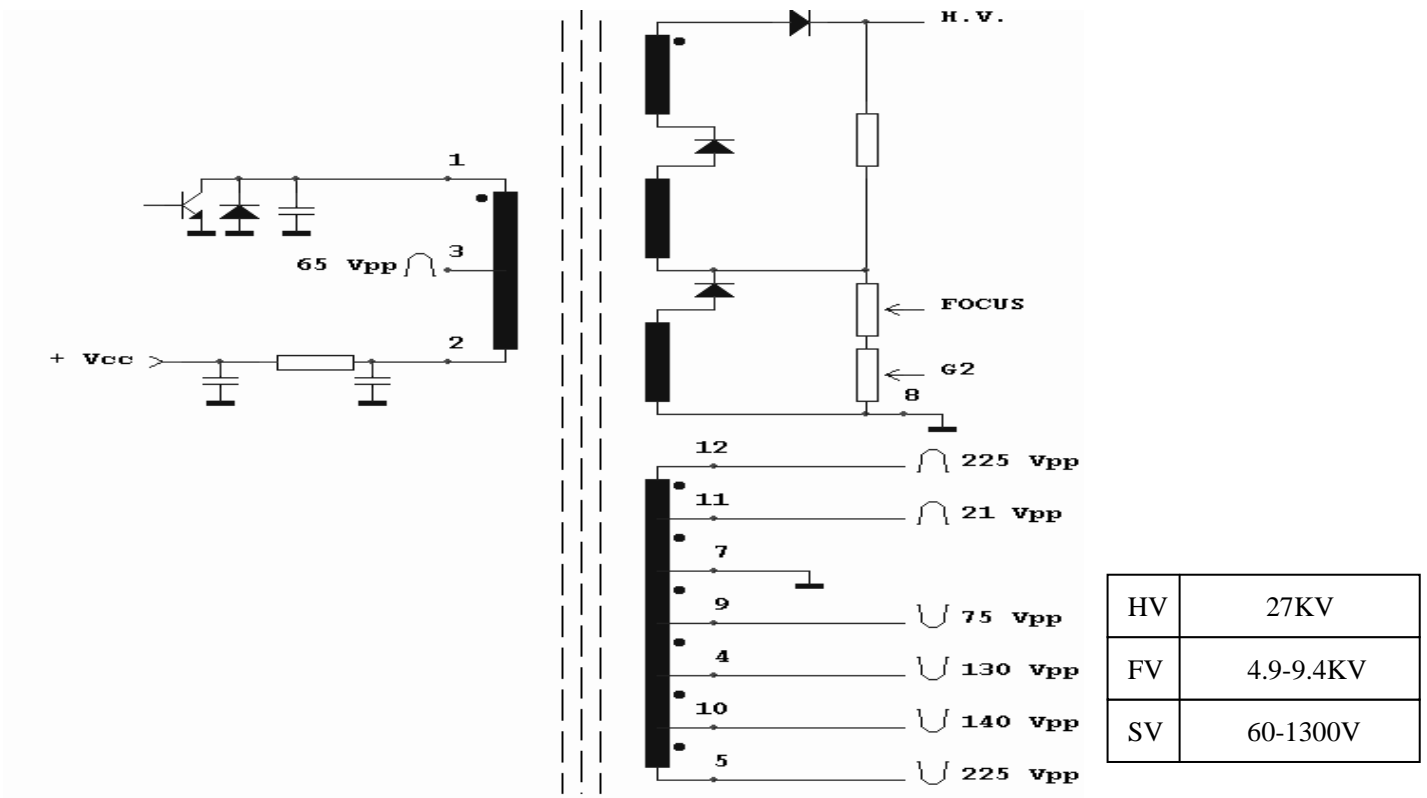

HR6483

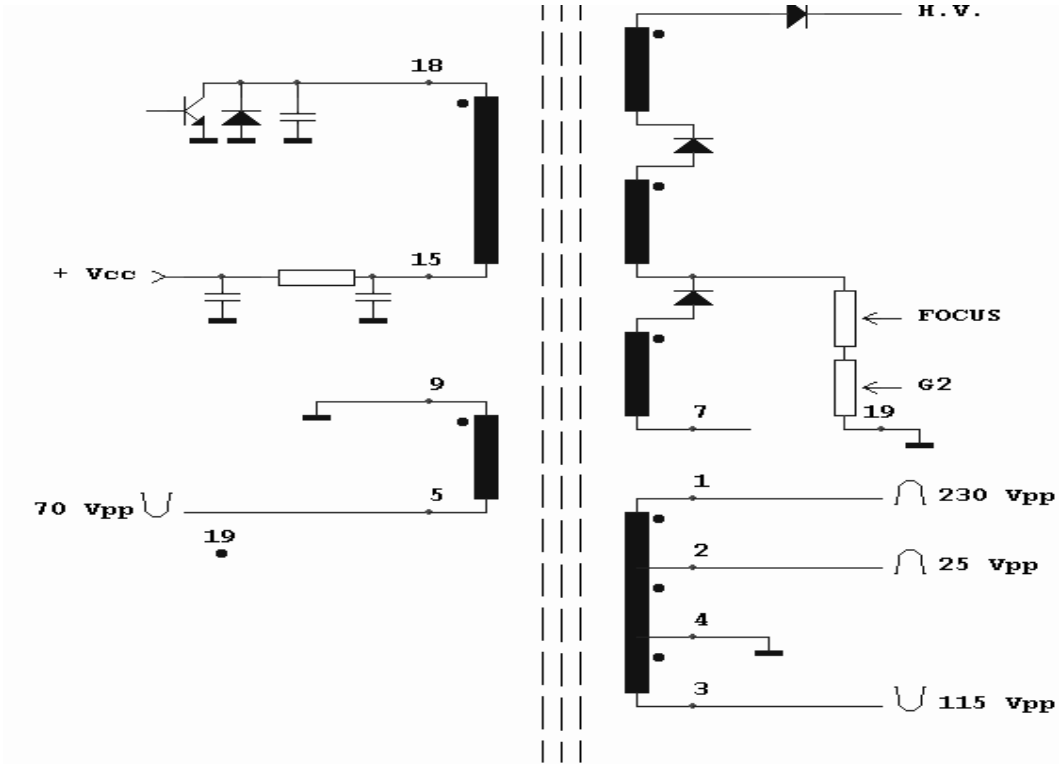

HV	27.9KV
FV	4.9-8.5KV
SV	50-1250V

HR6488

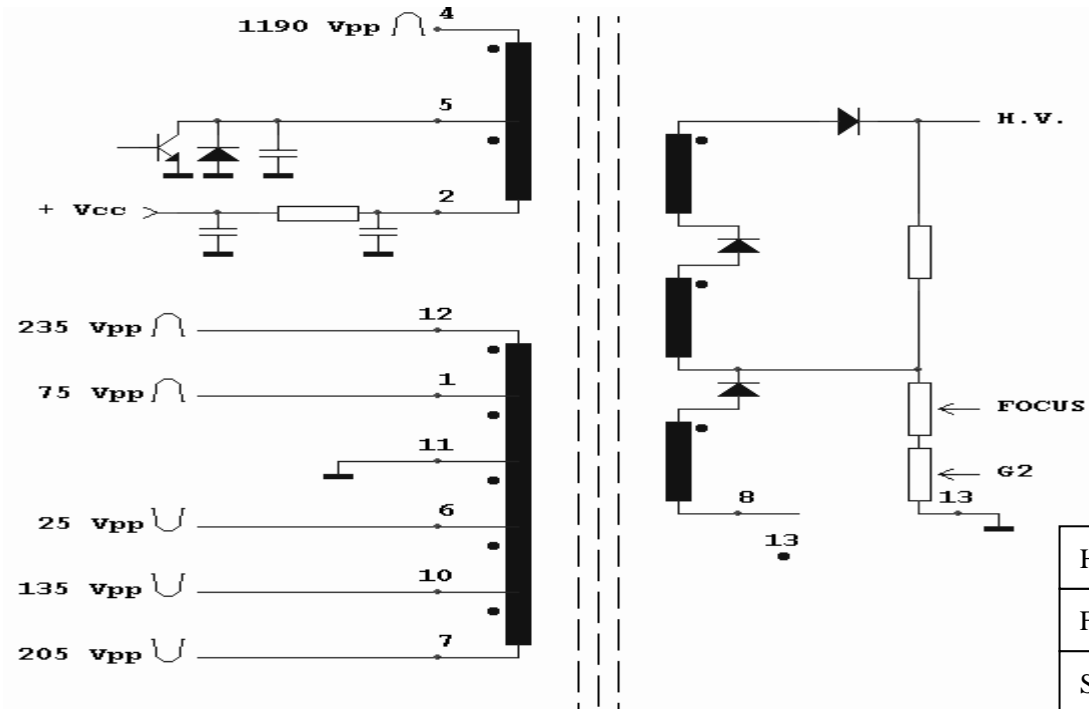

HV	26.7KV
FV	4.9-9KV
SV	5-1500V

HR6500

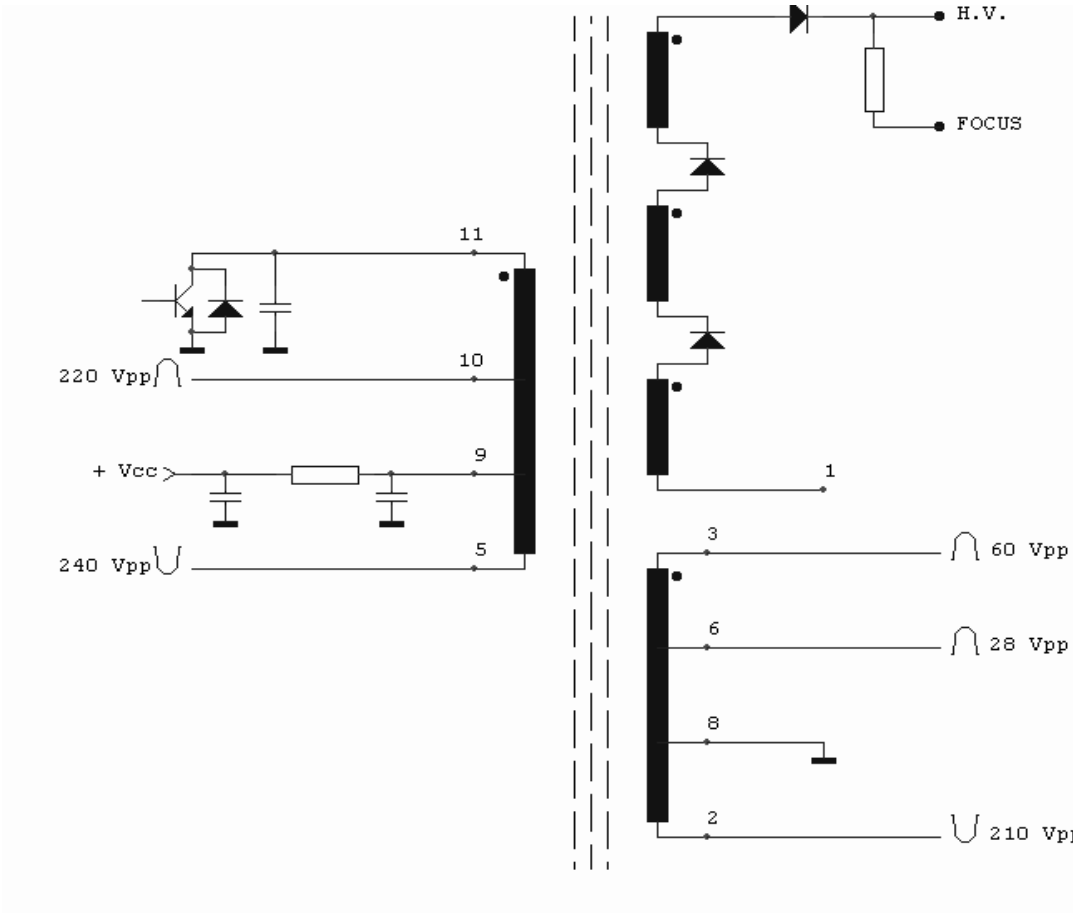

HV	27 KV
FV	18KV

HR6538

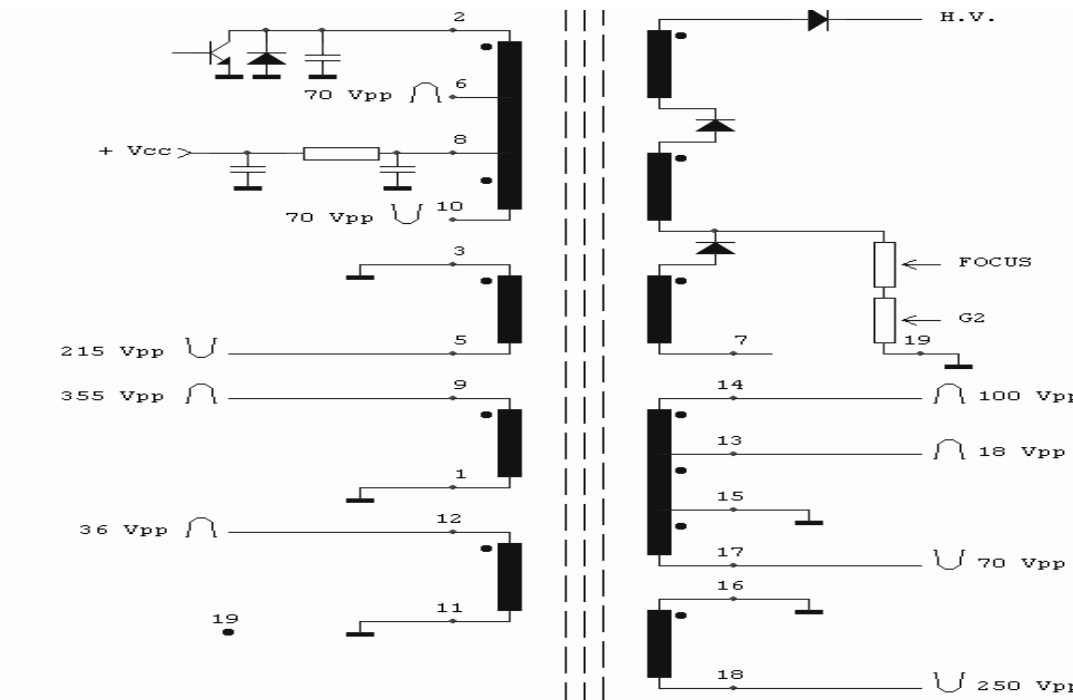

HV	27KV
FV	5.1-9.6 KV
SV	60-1500 V

HR6607

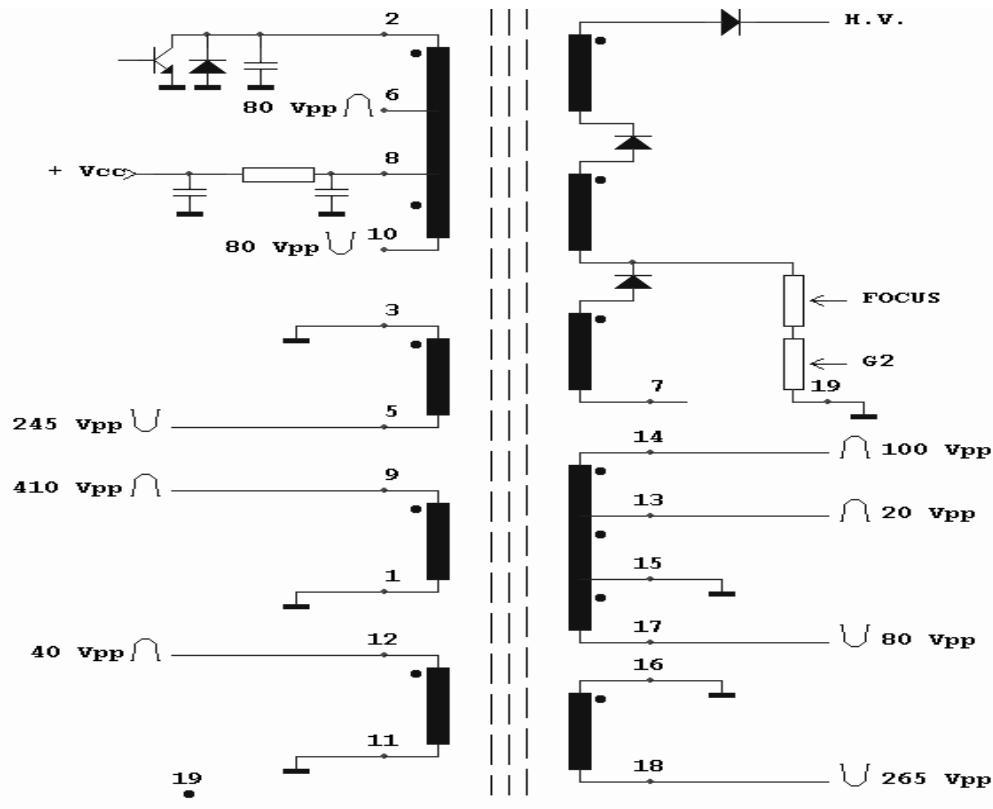

HR6609

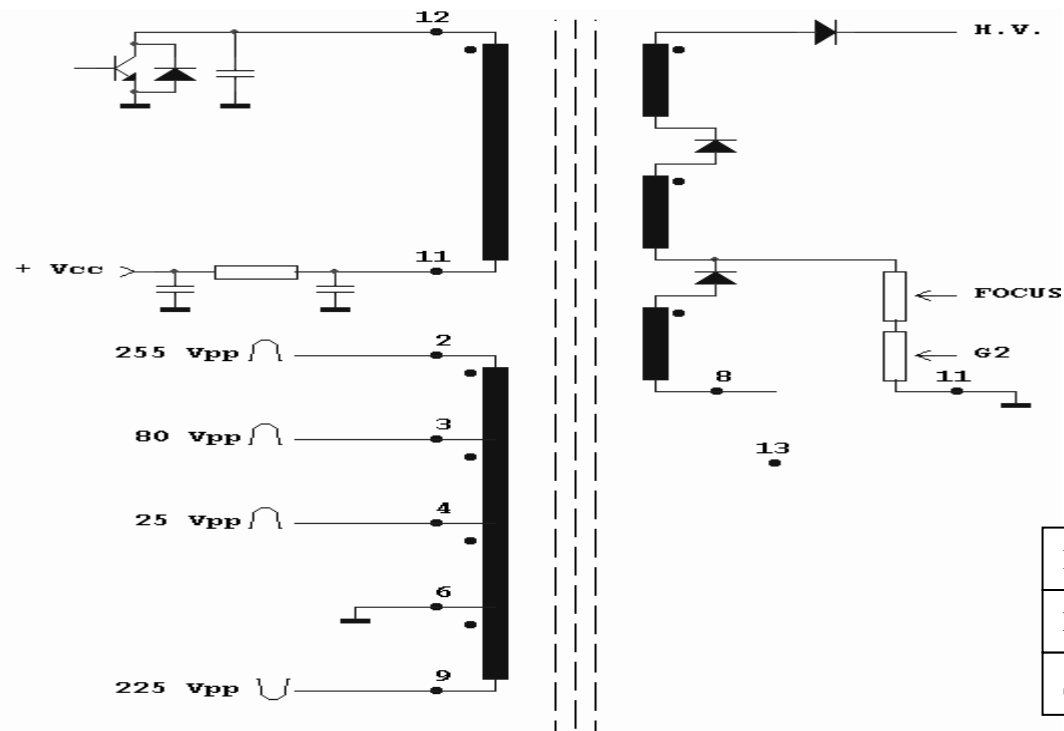

HR7094

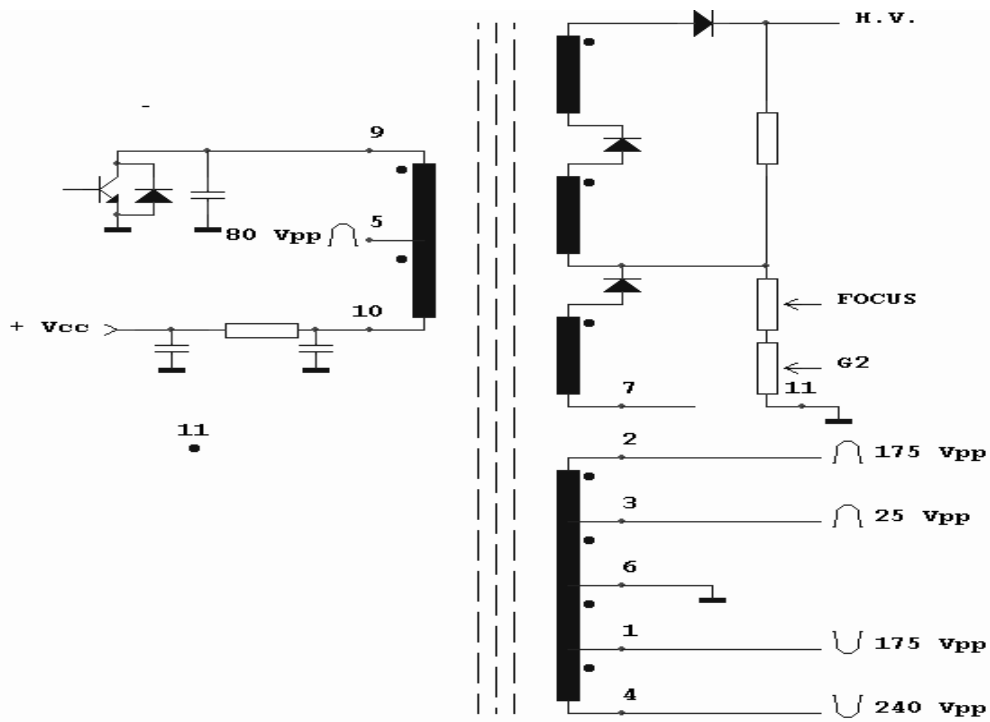

HV	27.2KV
FV	4.1-8.1KV
SV	5-1100V

HR7105

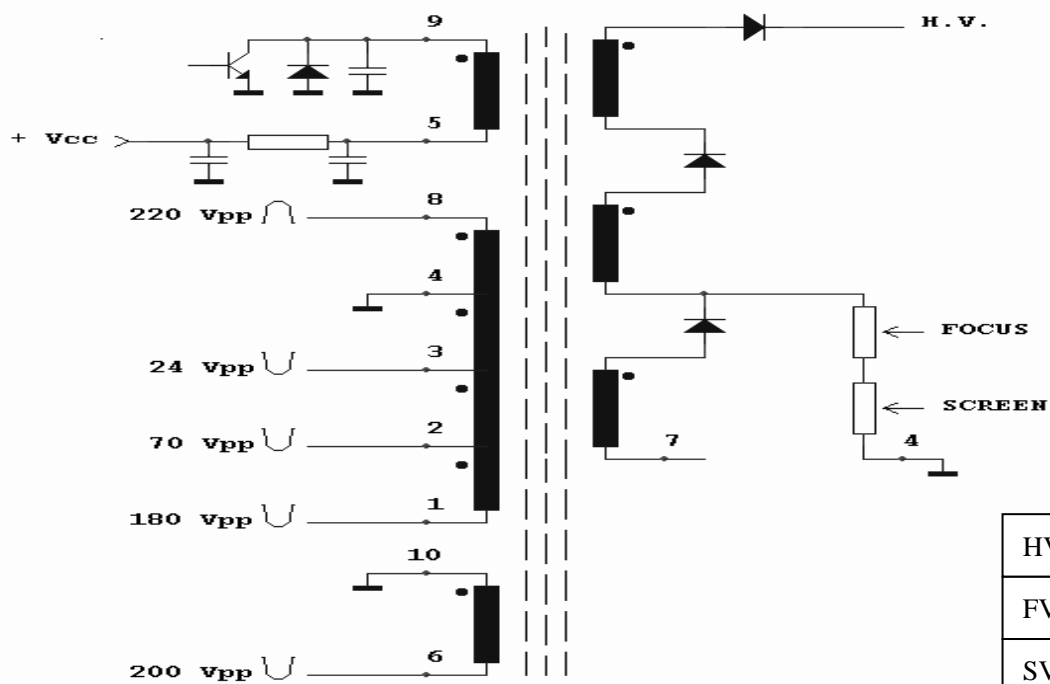

HV	26.8KV
FV	5-9.2KV
SV	20-1000V

HR7113

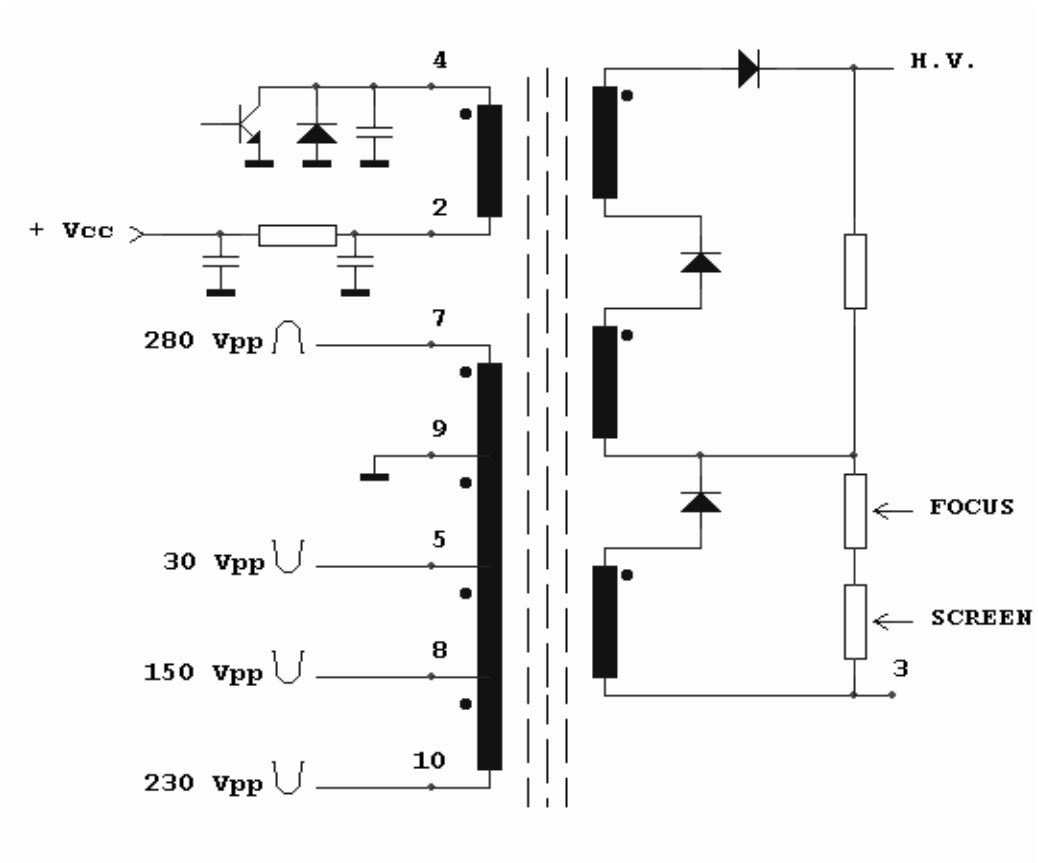

HV	25.5KV
FV	5.4-9.1KV
SV	10-1000V

HR7126

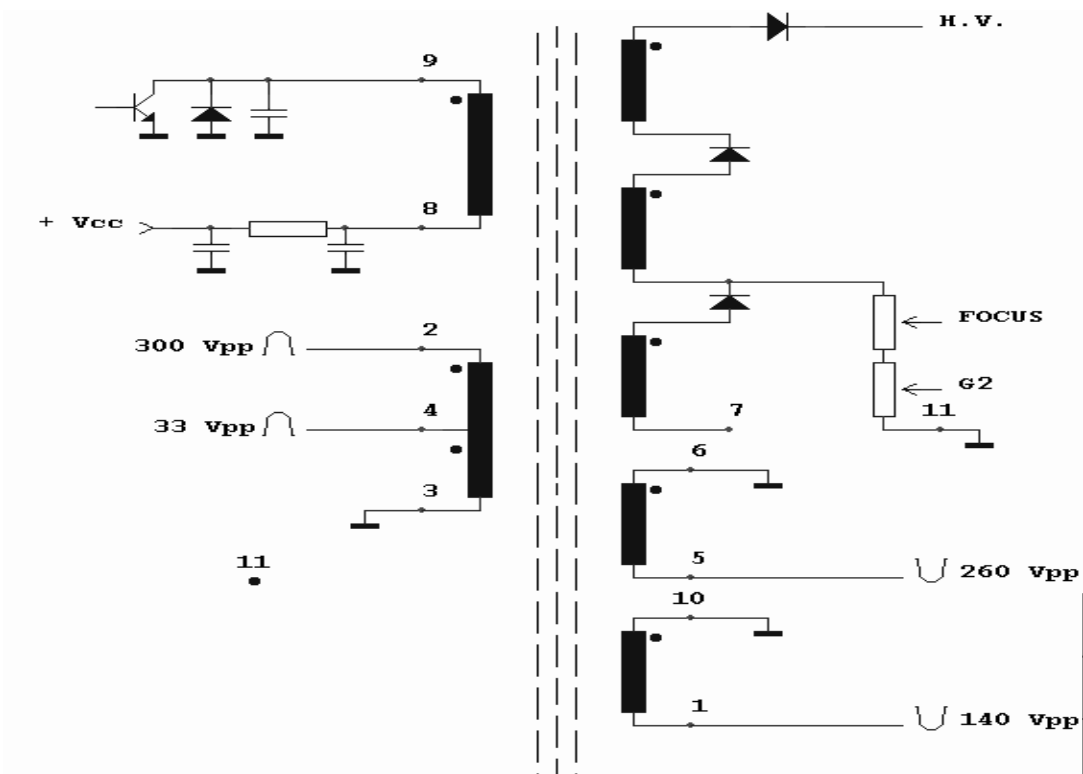

HV	28 KV
FV	4.6-9.5KV
SV	30-895V

HR7128

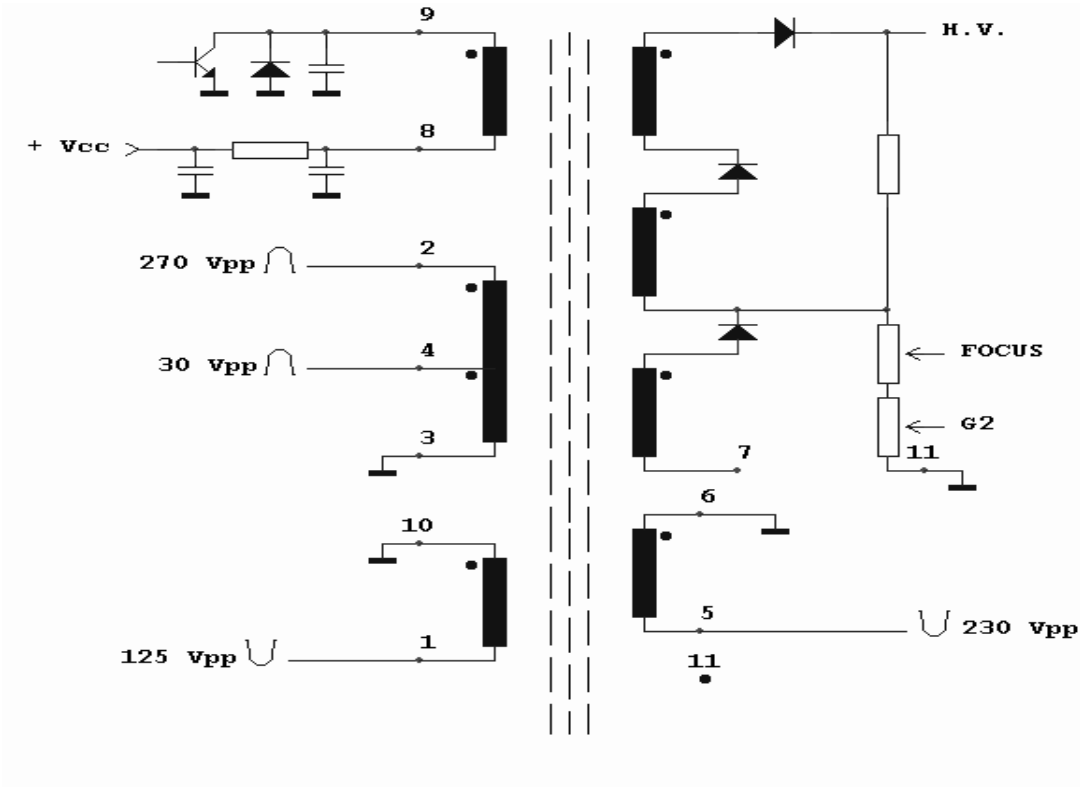

HR7196

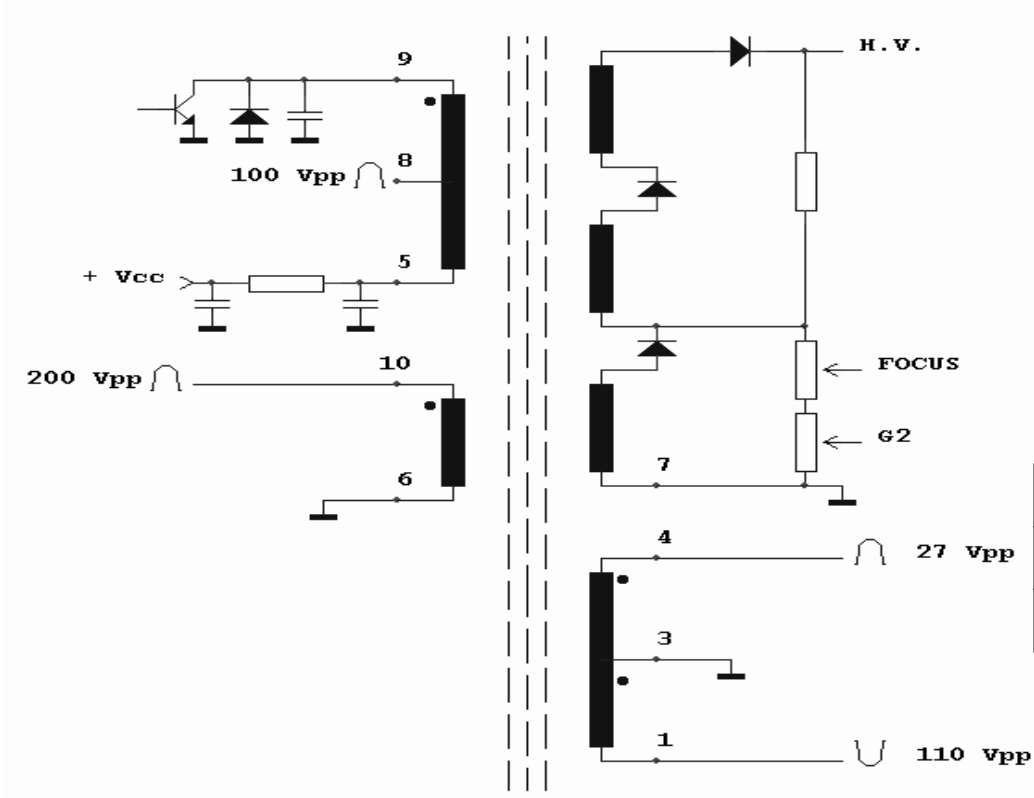

HR7225

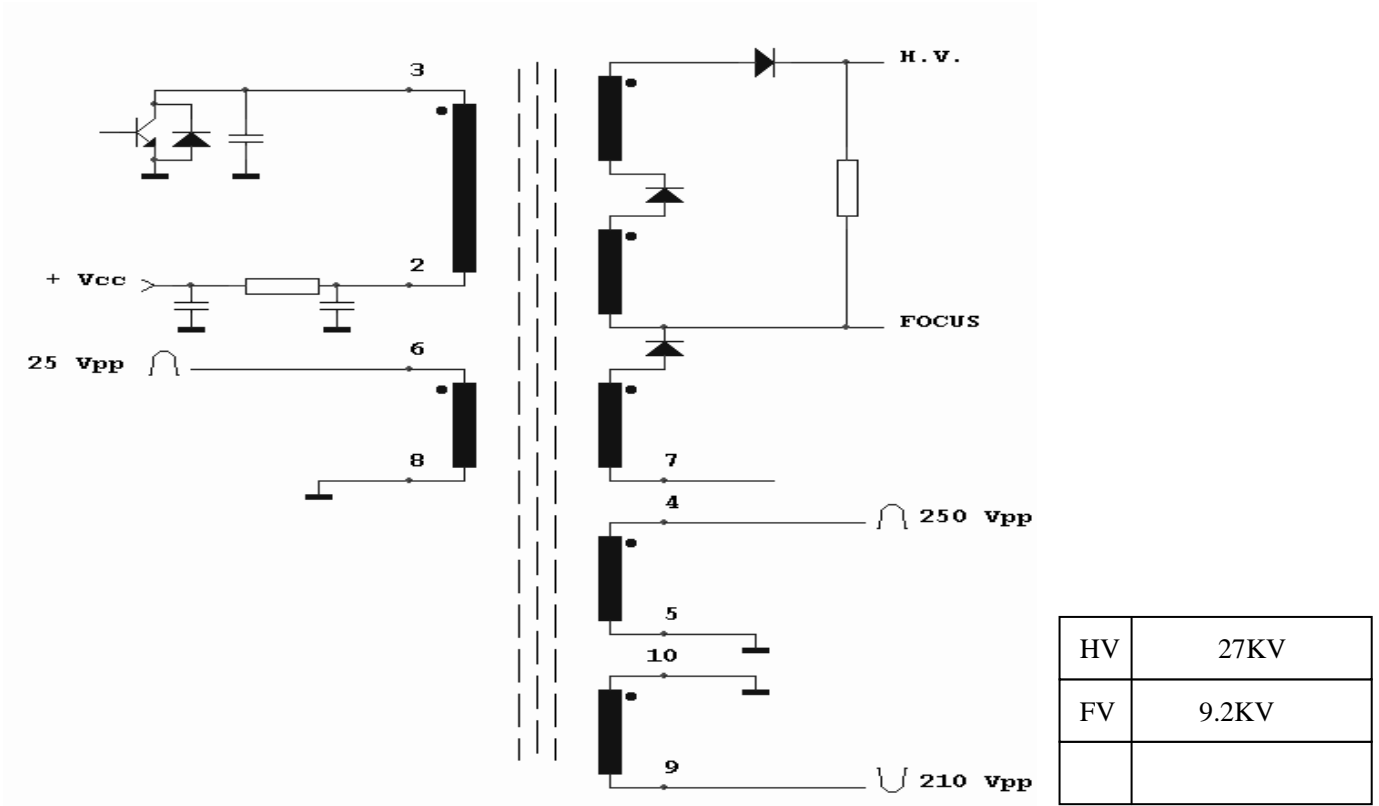

HR7279

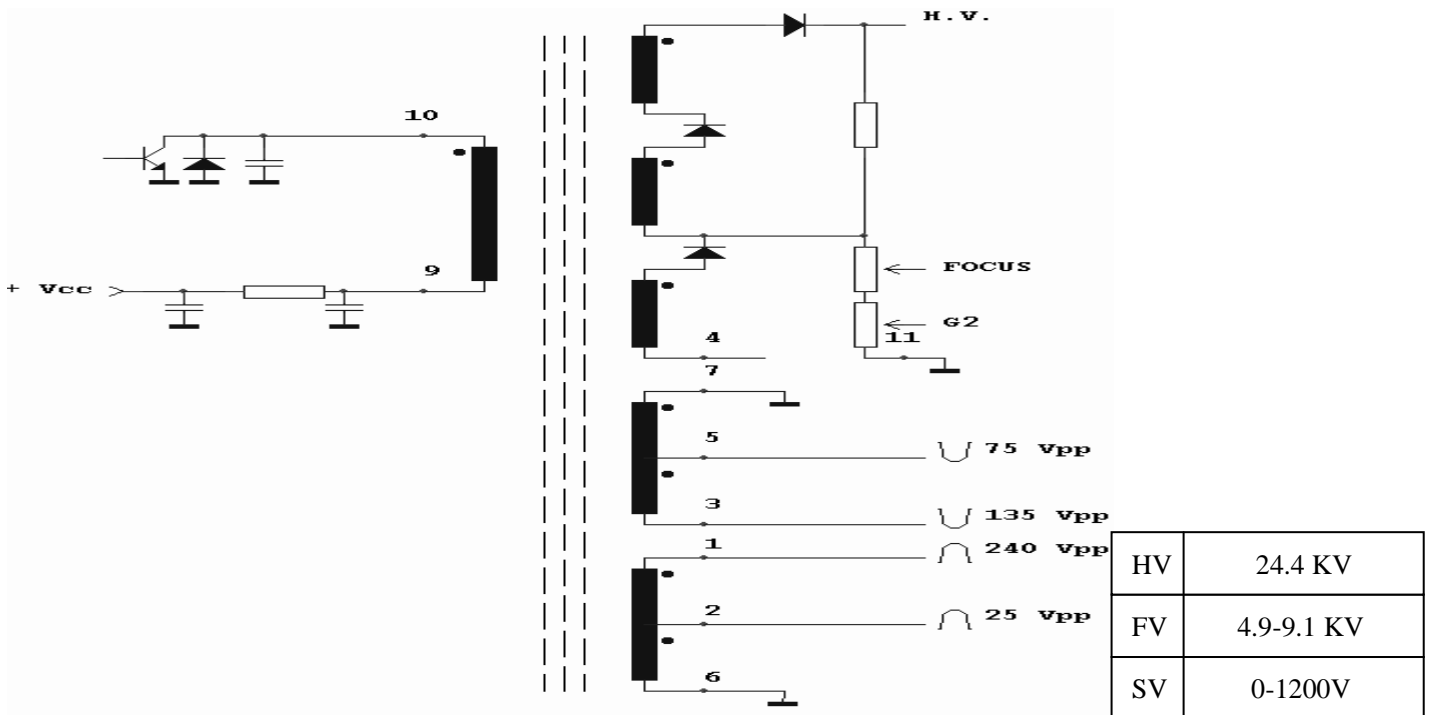

HR7296

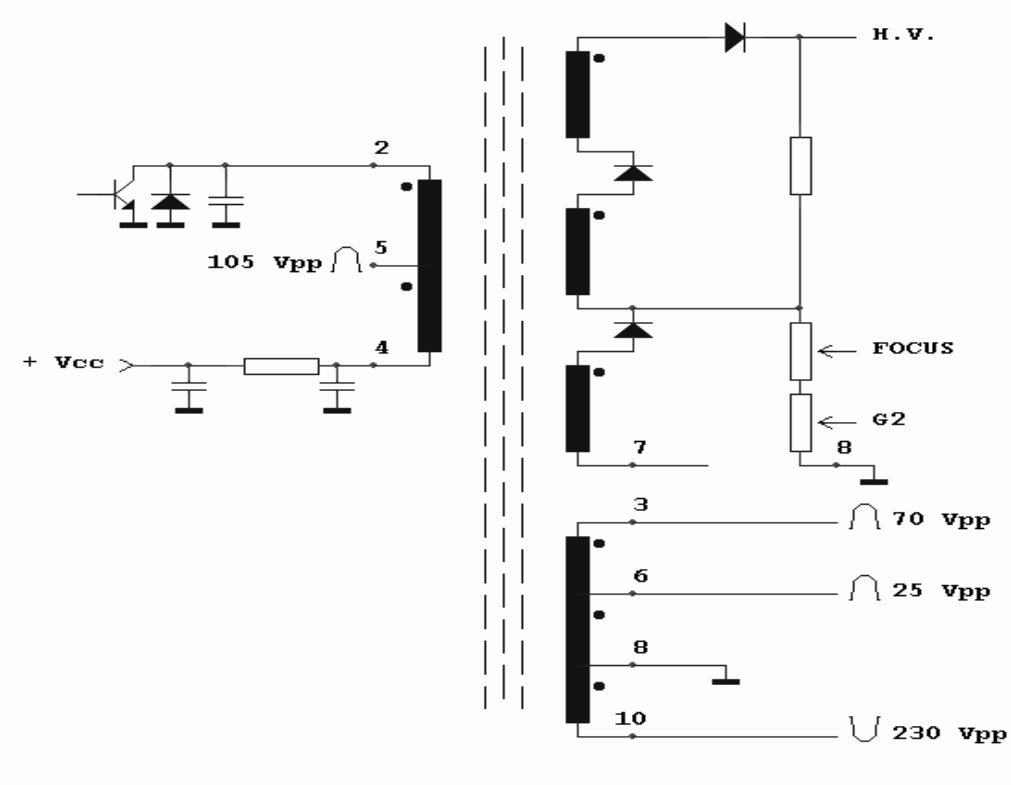

HV	25 KV
FV	4-7.9KV
SV	5-1090V

HR7299

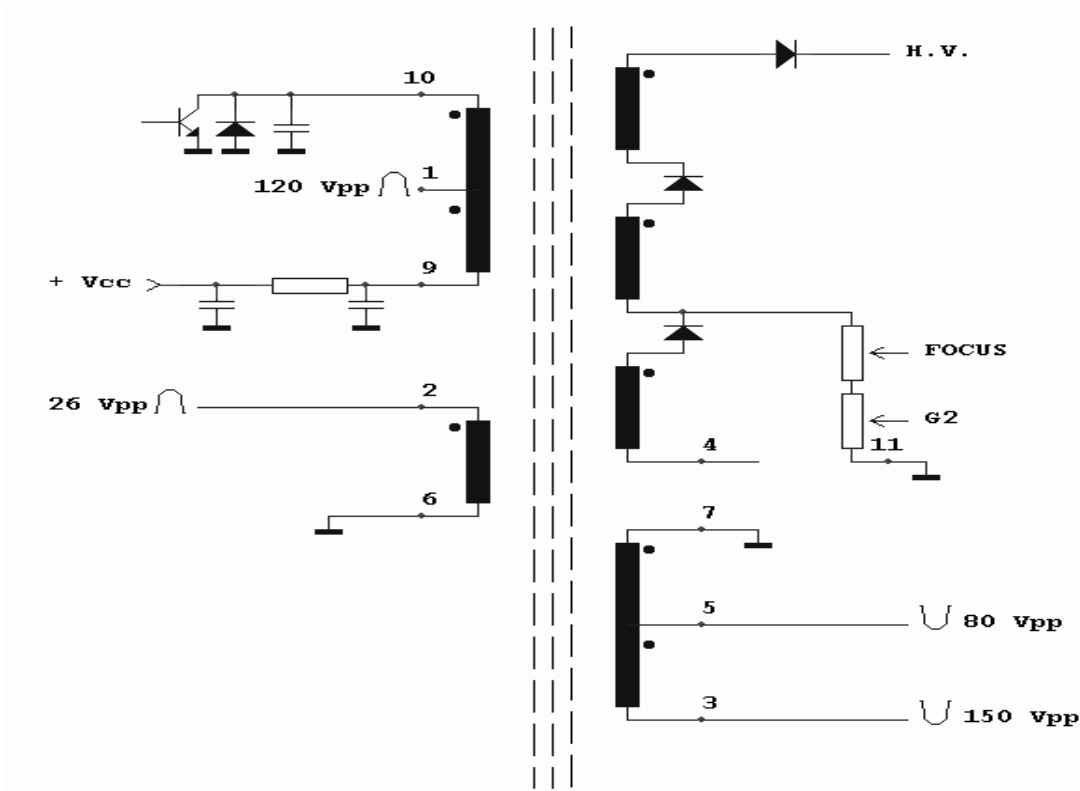

HV	28.1 KV
FV	4.9-8.8KV
SV	80-1025V

HR7317

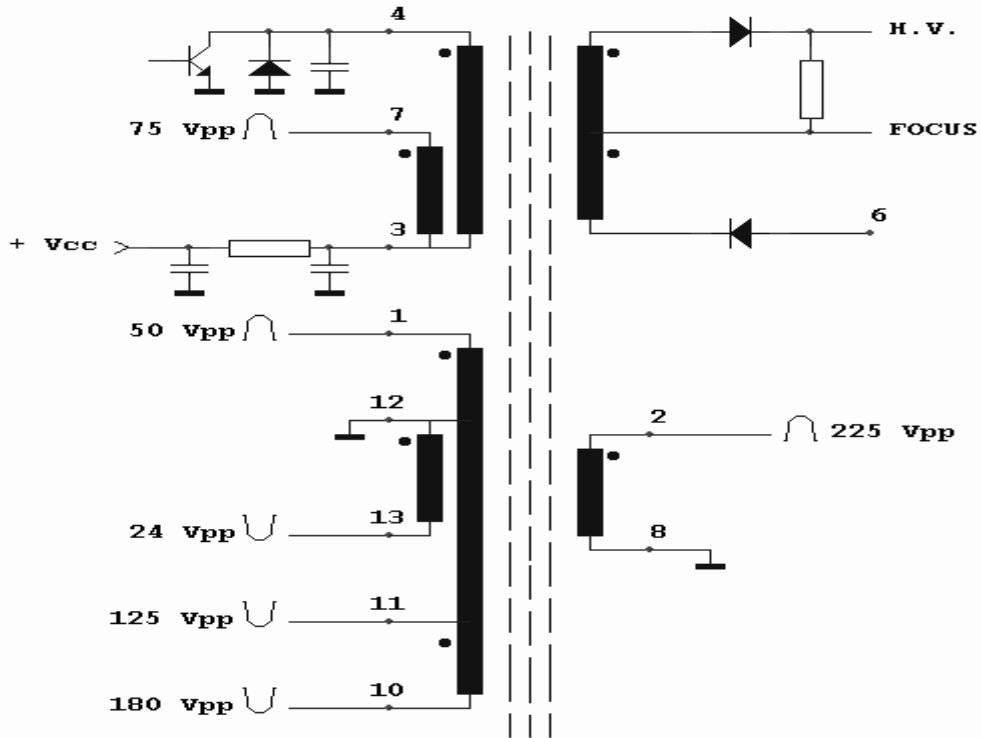

HV	24KV
FV	7.2 KV

HR7323-00

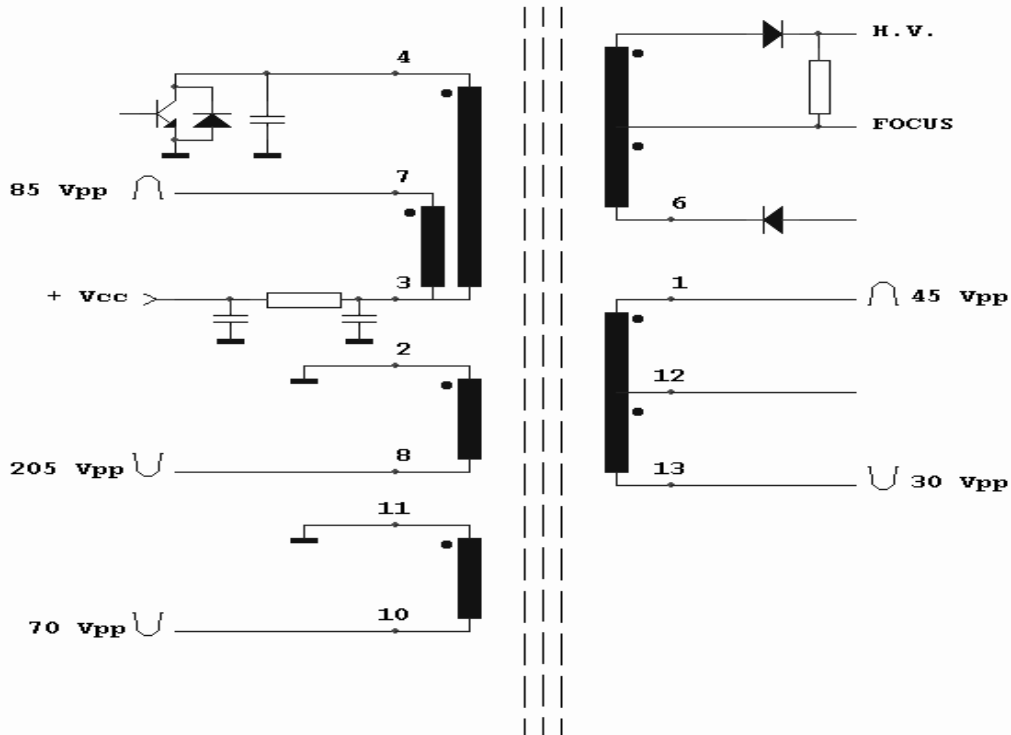

HV	27.3KV
FV	12KV

HR7337

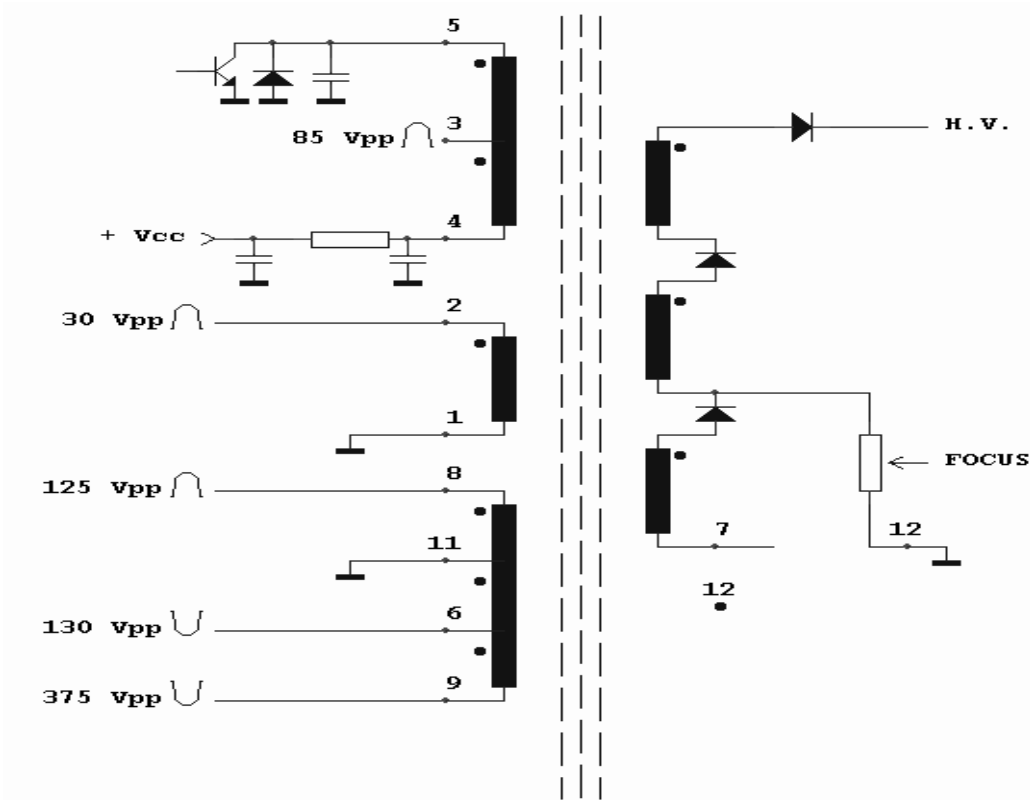

HR7360

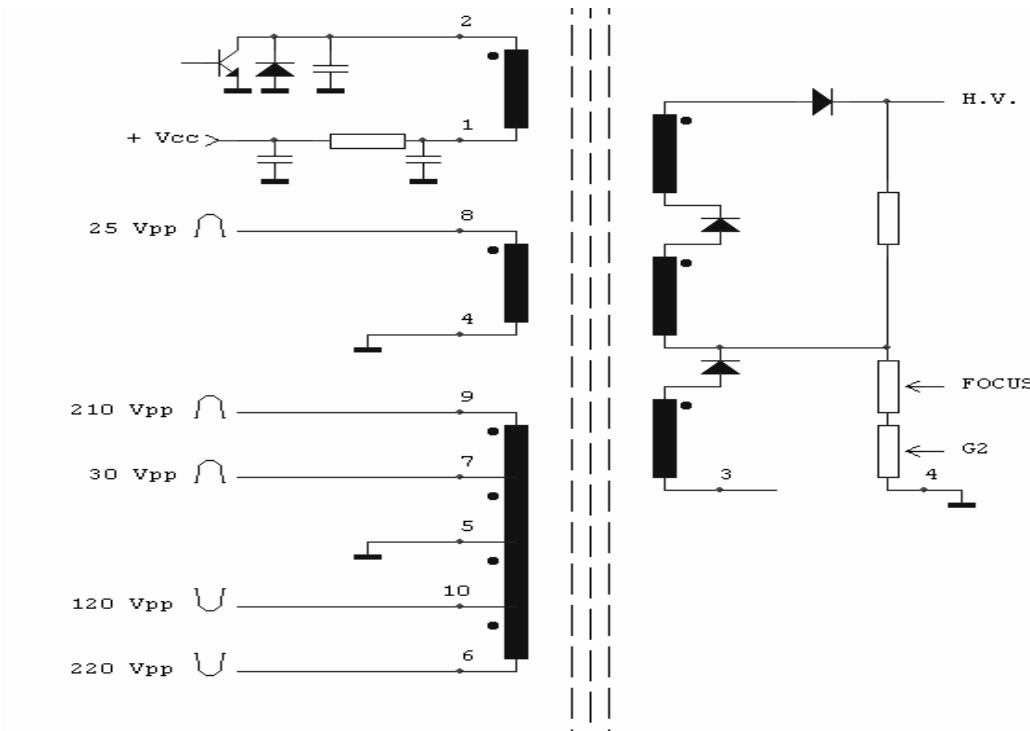

HR7443

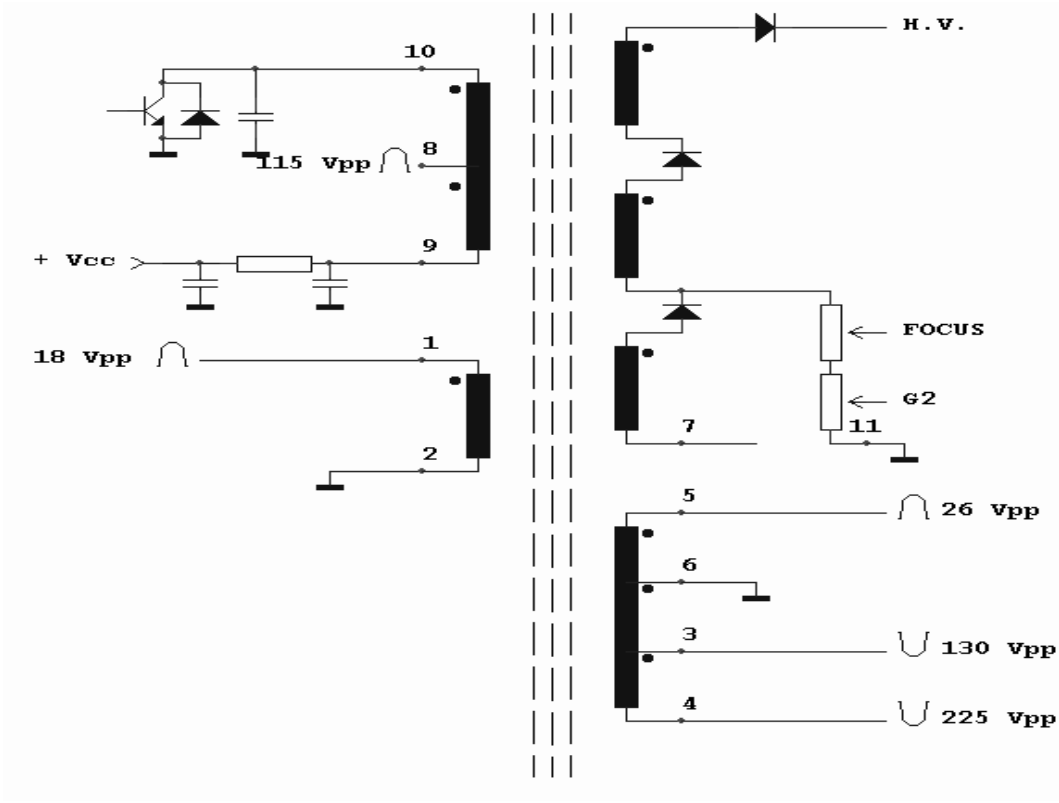

HV	26.4KV
FV	4.9-9 KV
SV	50-862V

HR7491

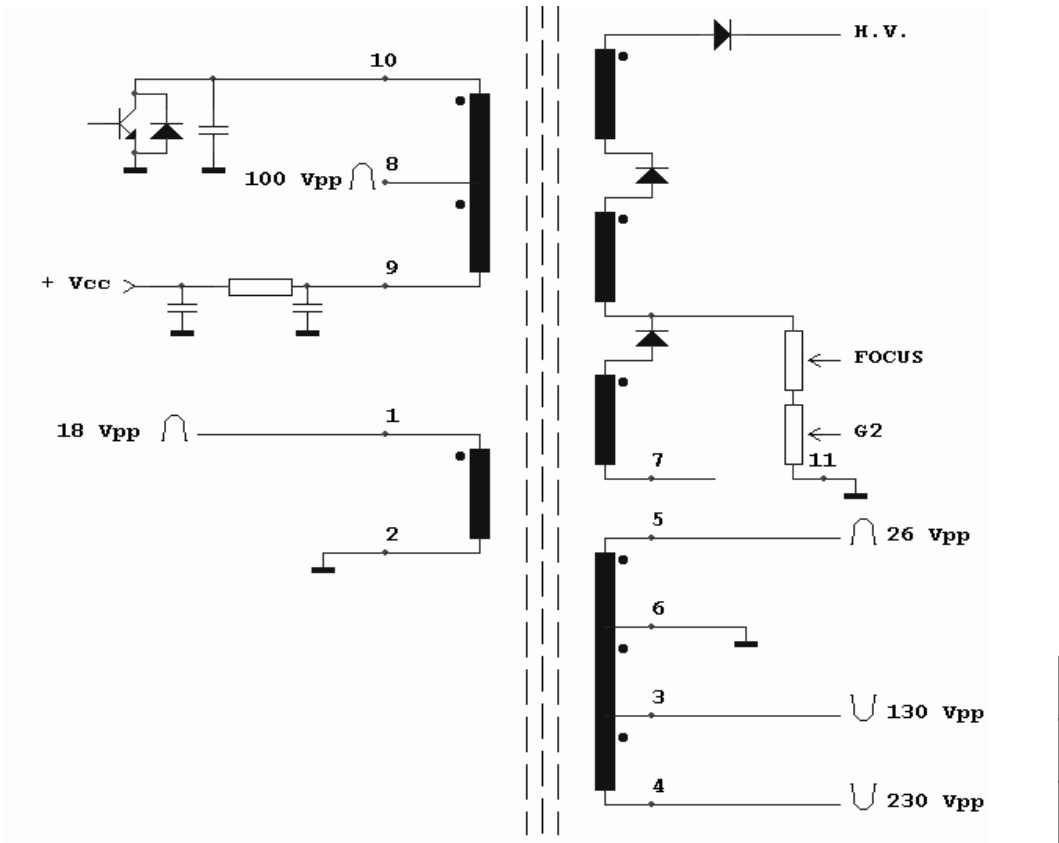

HV	24.9KV
FV	4-6.9 KV
SV	0-1010 V

HR7503

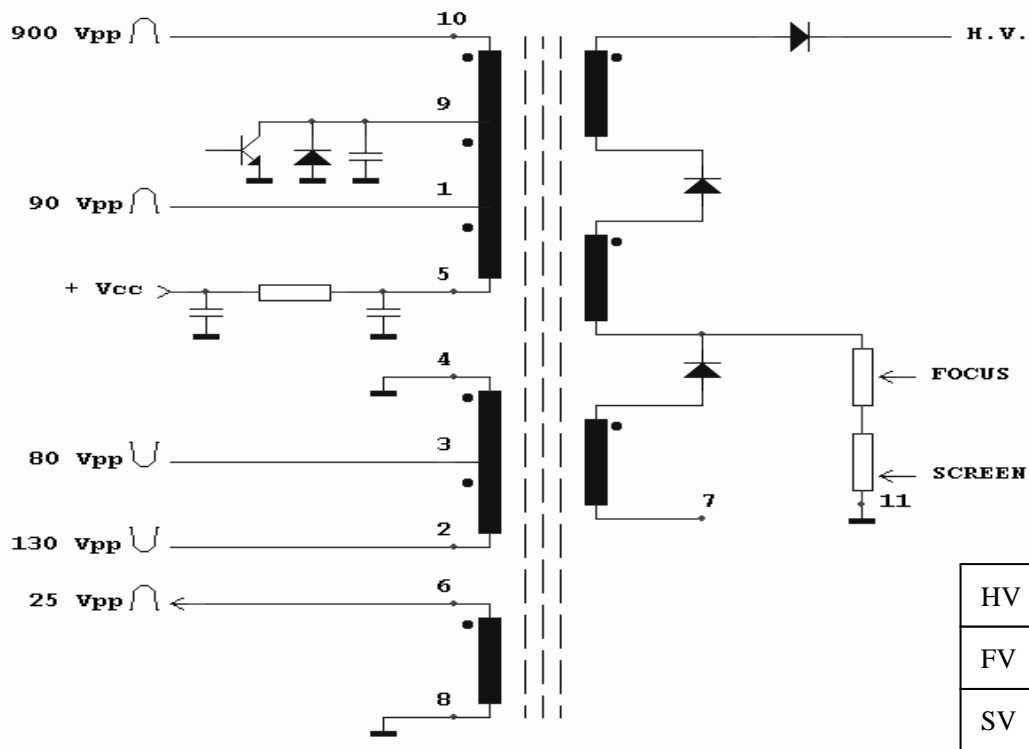

HR7527

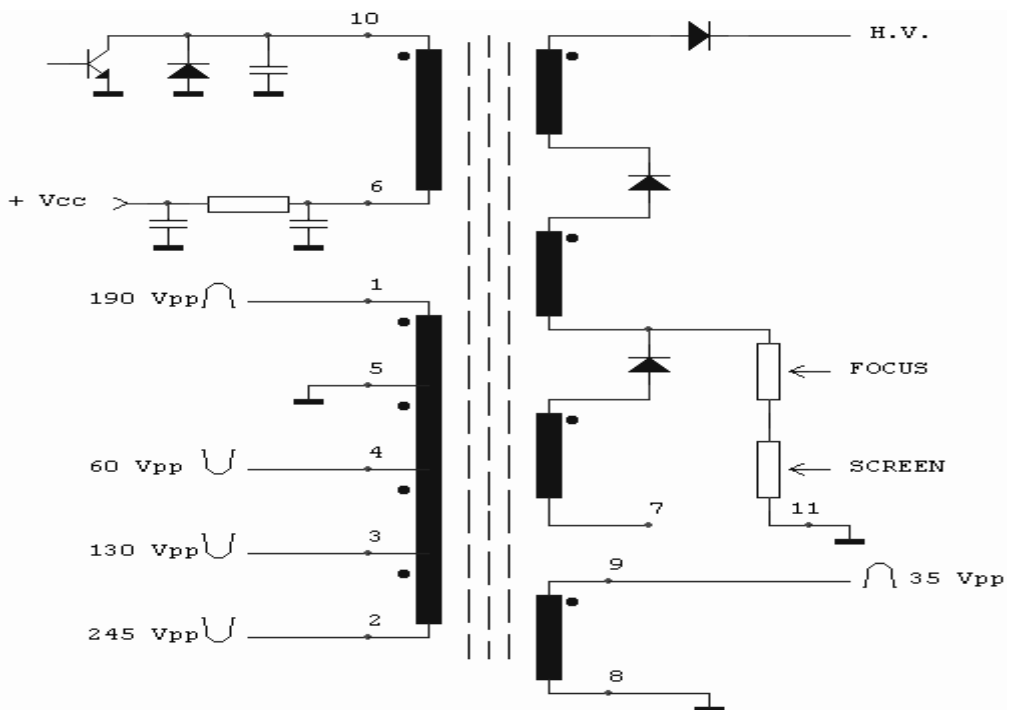

HR7559

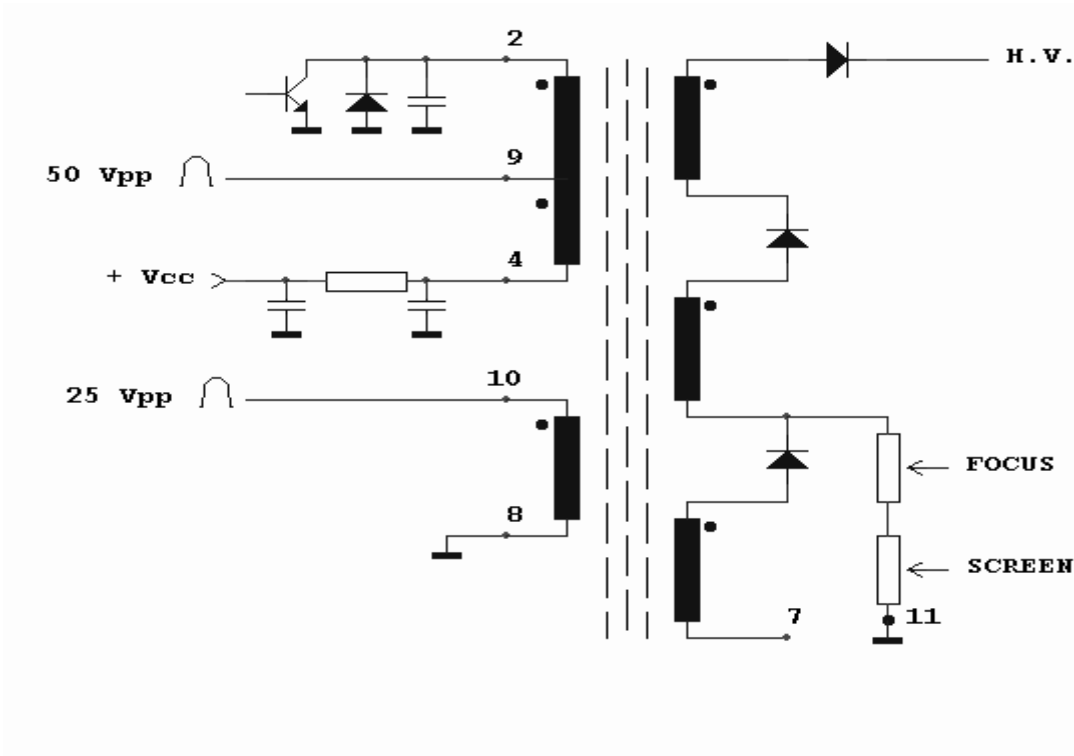

HR7880



HR7898

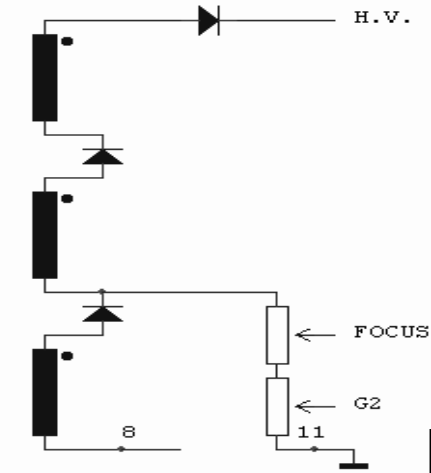
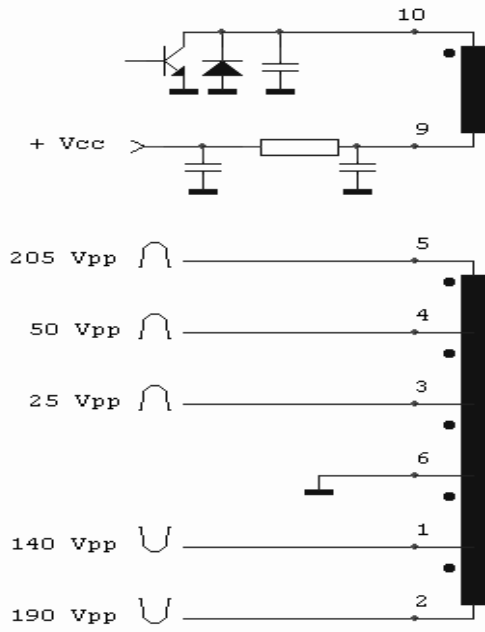

HV	27KV
FV	5-9.4KV
SV	50-800V

HR7906

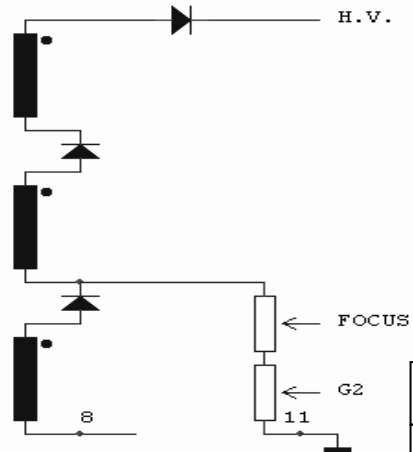
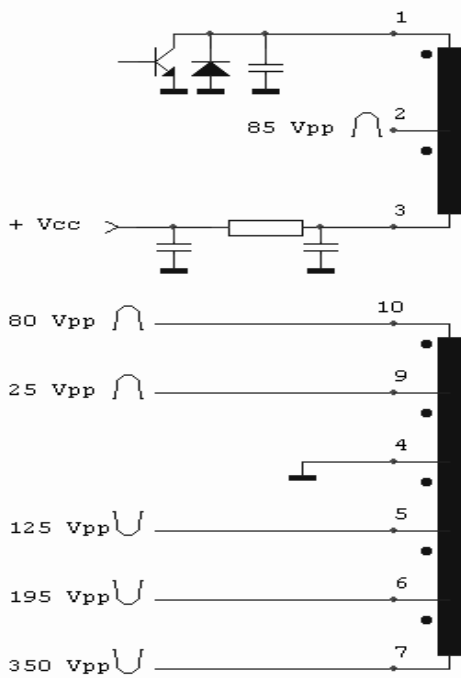

HV	27 KV
FV	4-7.2KV
SV	1-950V

HR7927

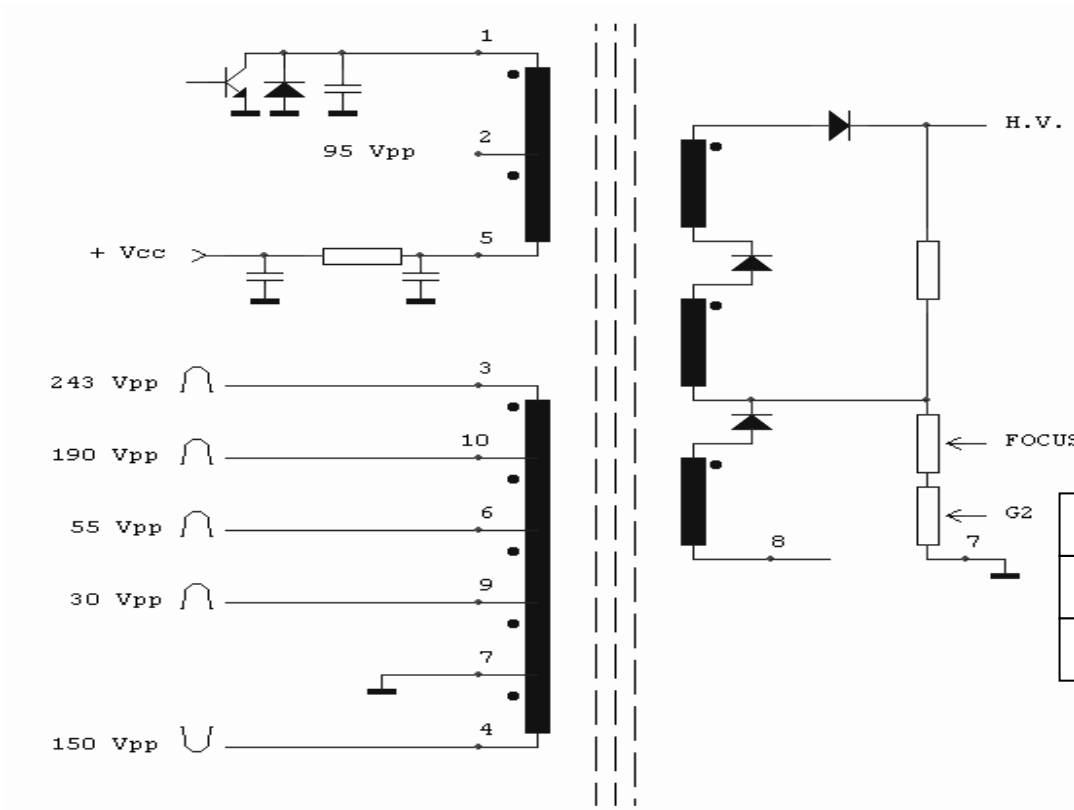

HR7950

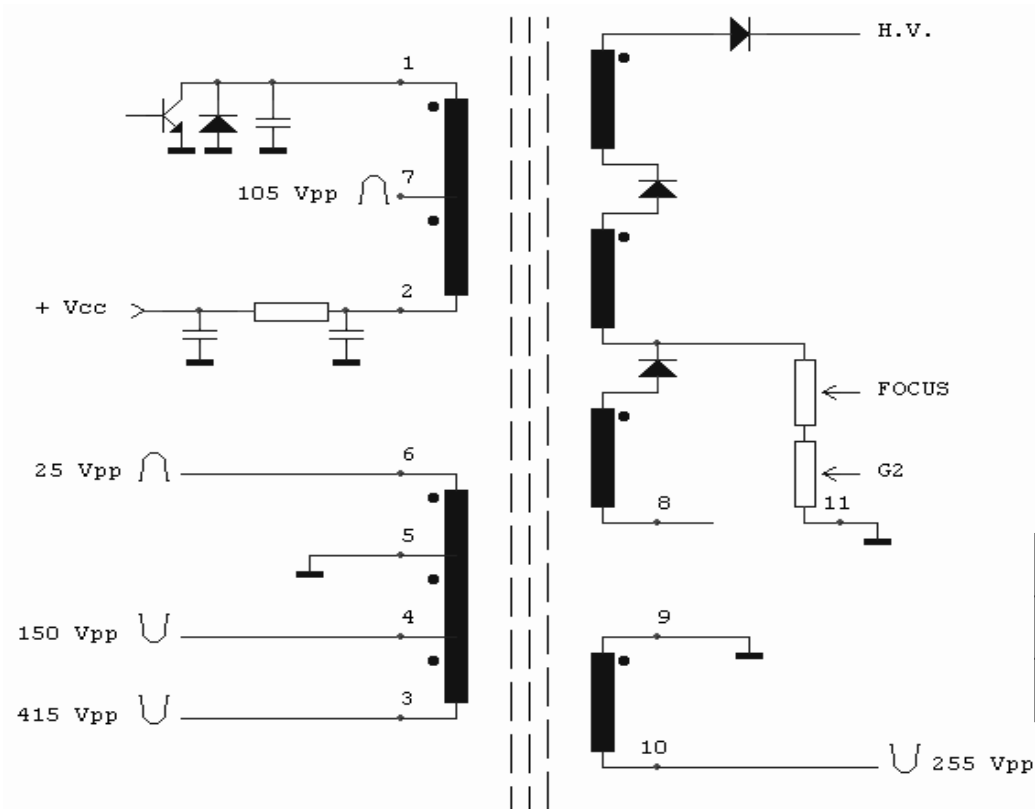

HR7977

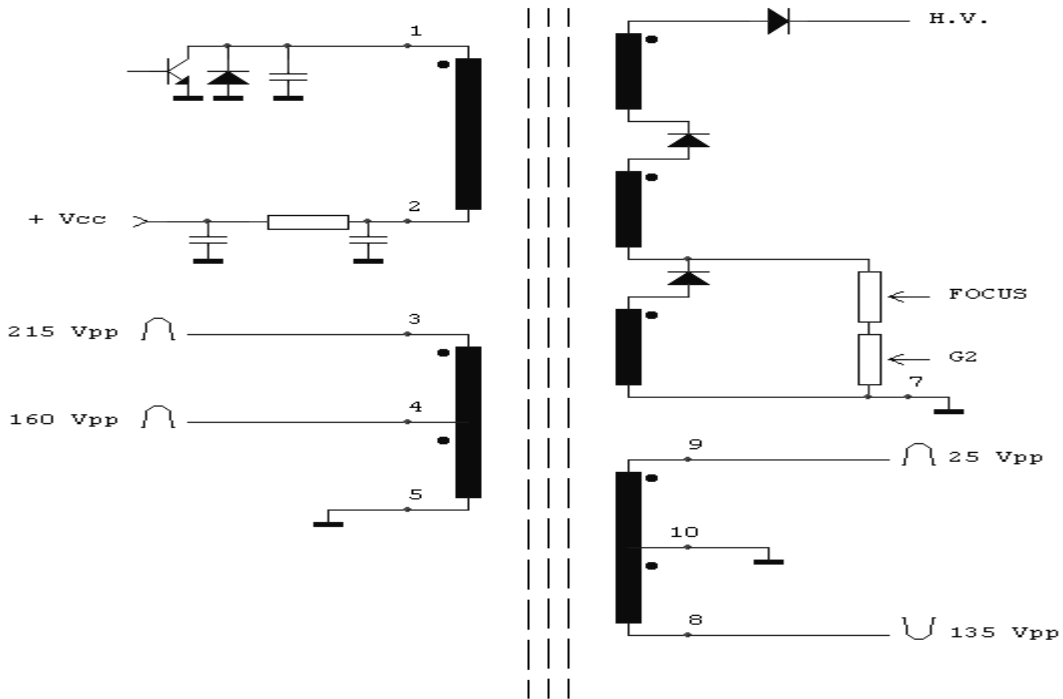

HR8007

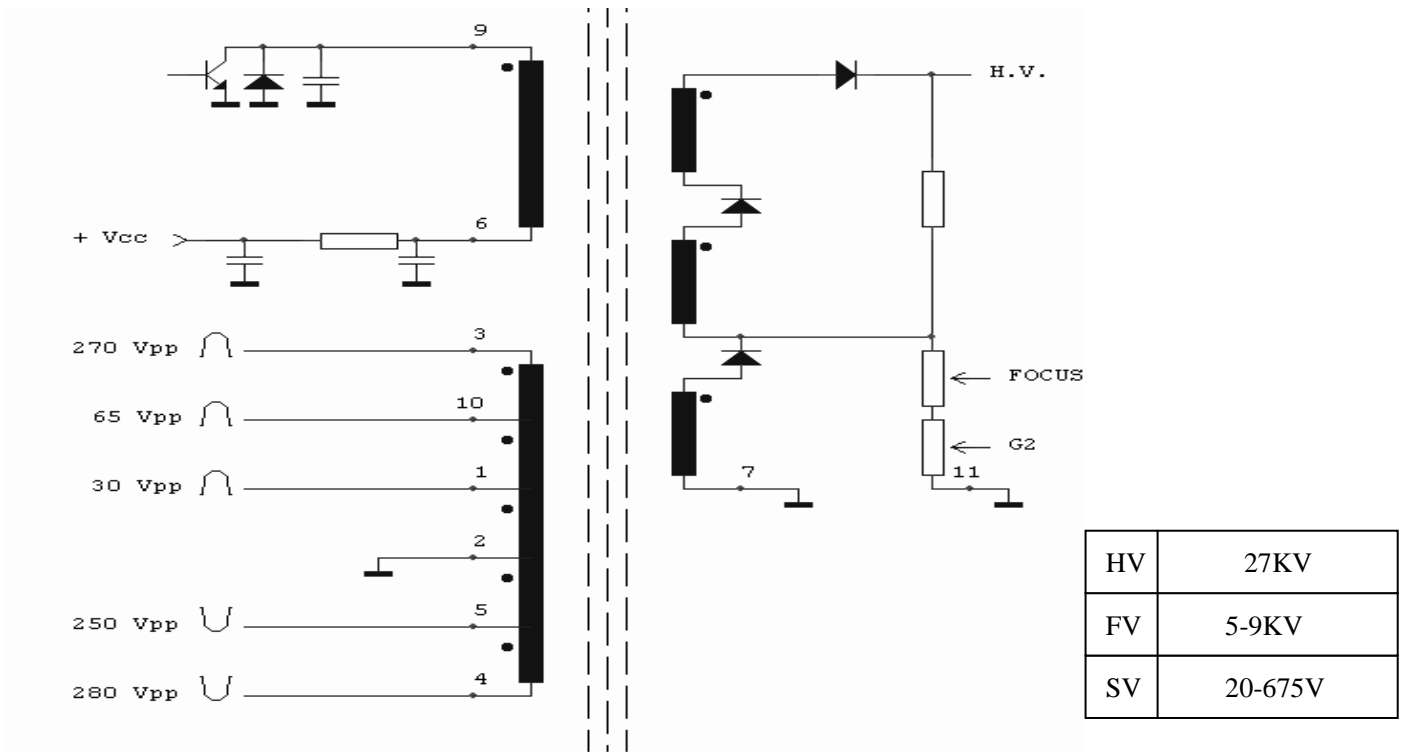

HR8029

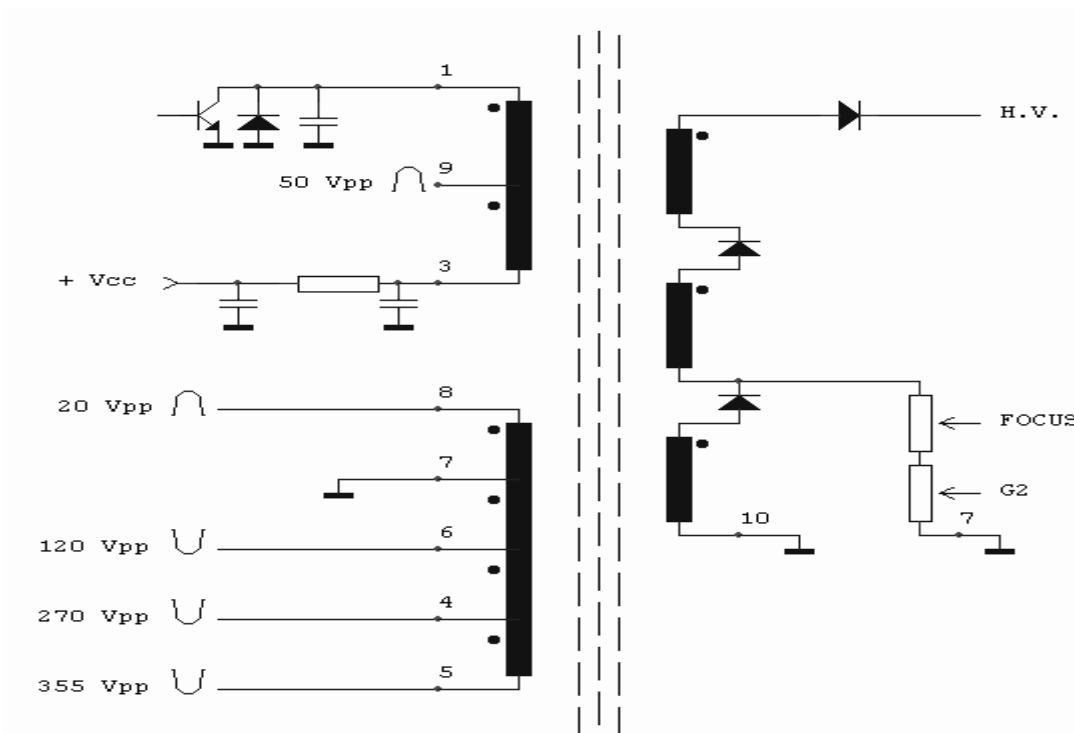

HV	25.2 KV
FV	4.1-8KV
SV	10-700V

HR8051

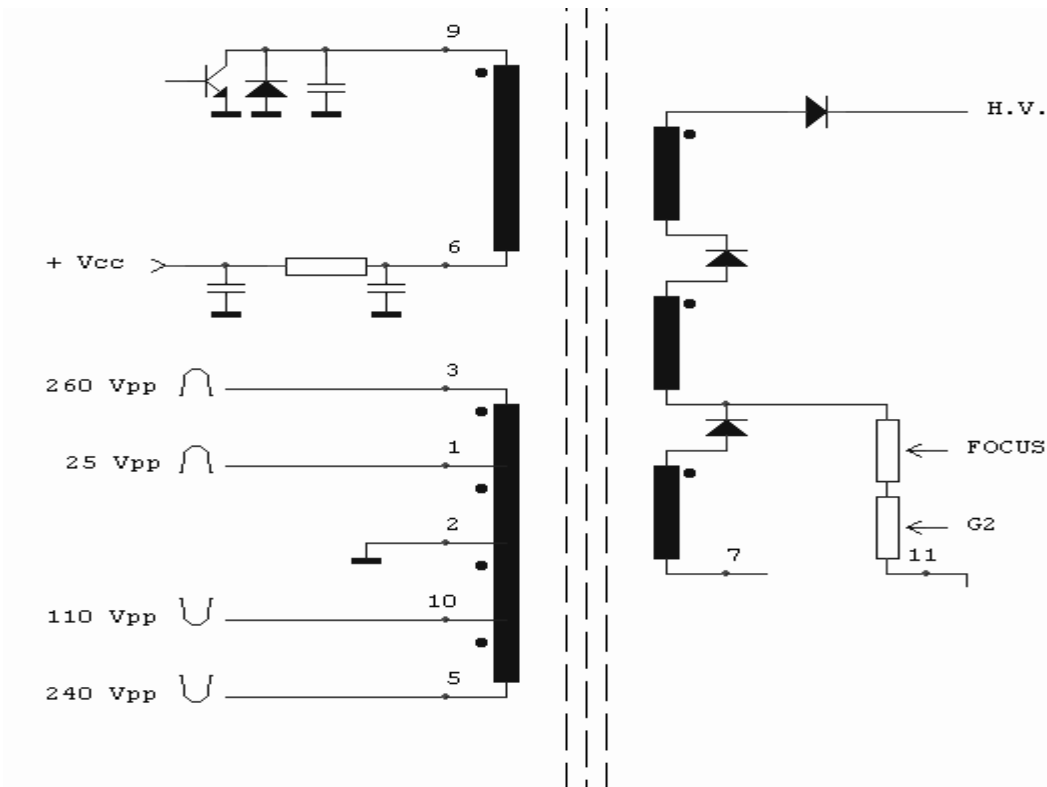

HV	26.8 KV
FV	5-9.1KV
SV	10-700V

HR8118

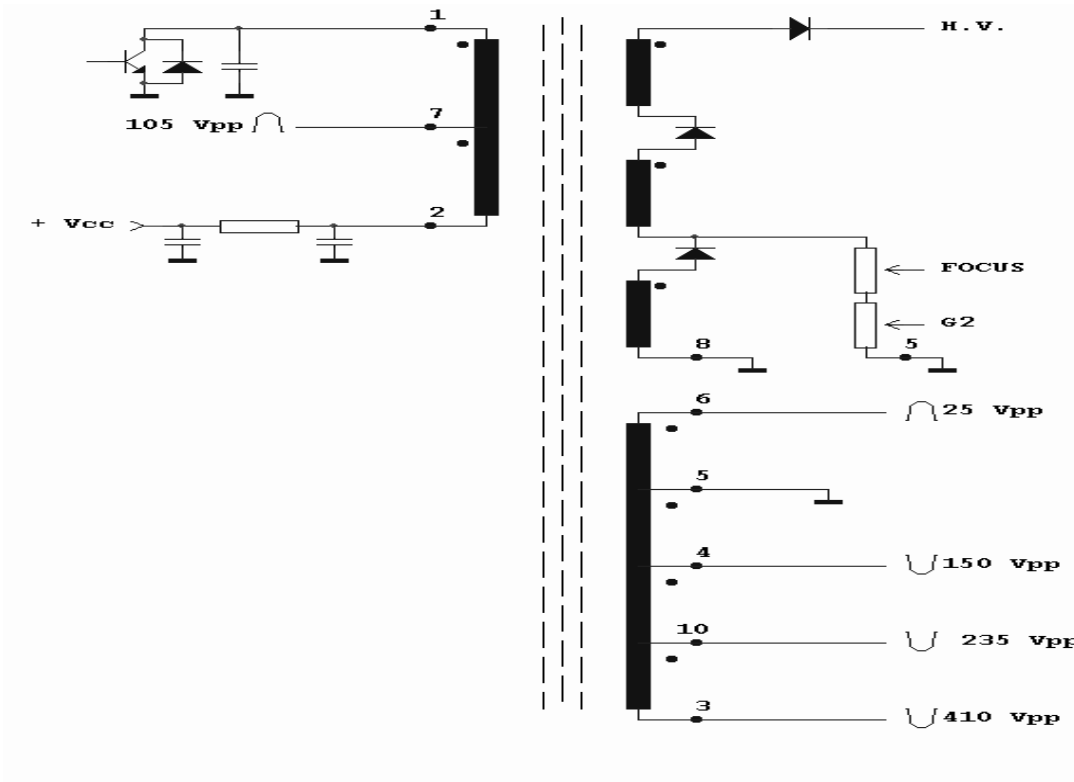

HV	26.1 KV
FV	5-9.9KV
SV	25-980V

HR8188

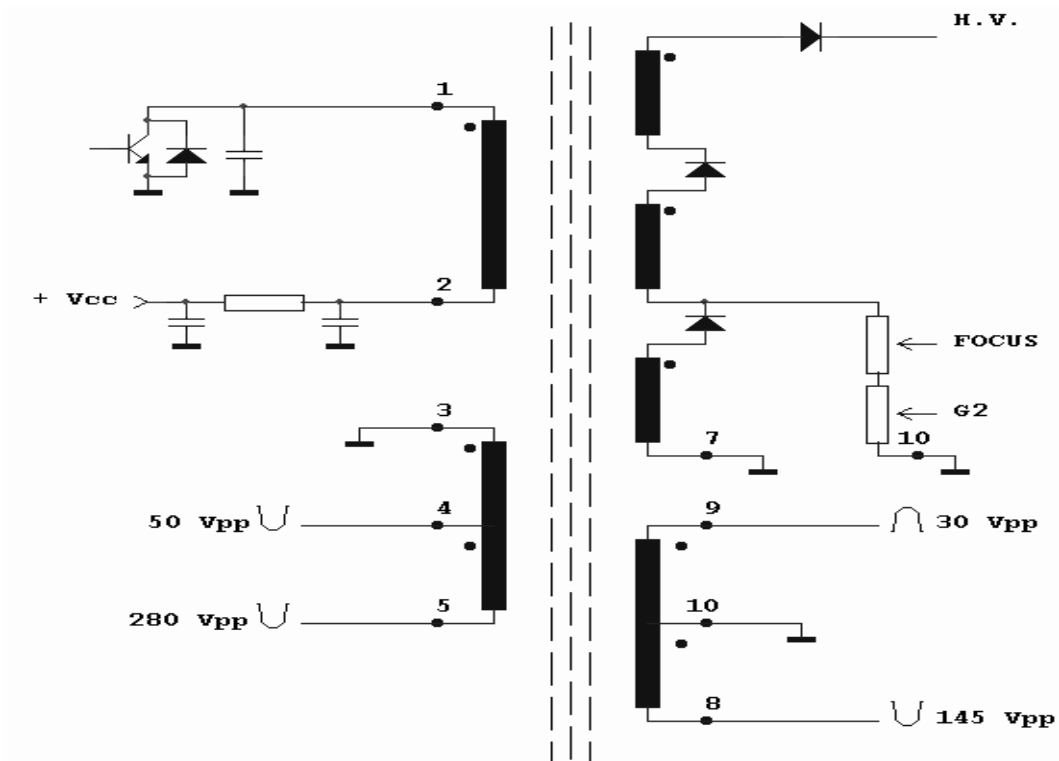

HV	27.7KV
FV	5.2-9.6KV
SV	20-820V

HR8196

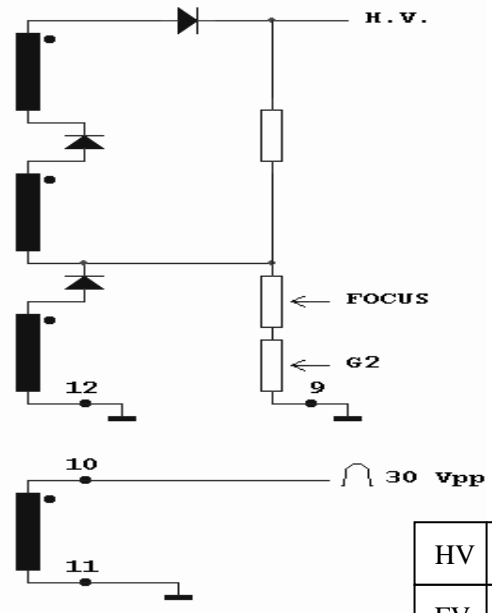
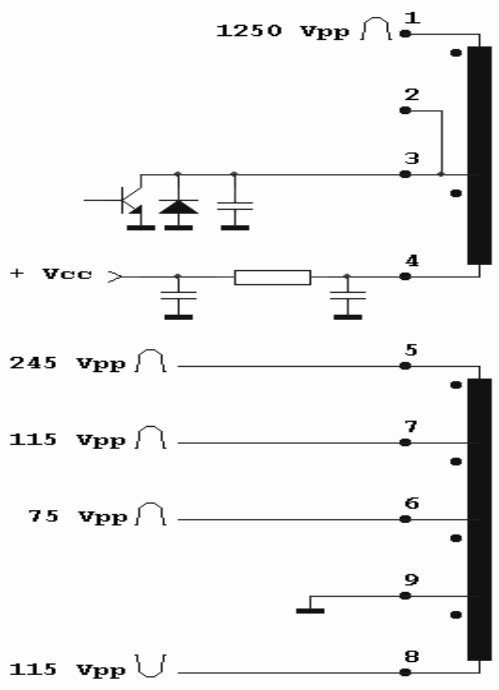

HV	27.1KV
FV	5-9.7KV
SV	80-840V

HR8316

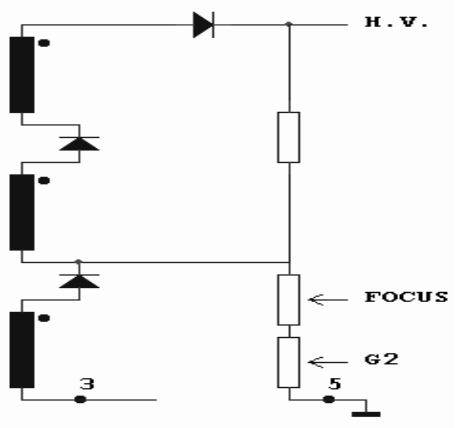
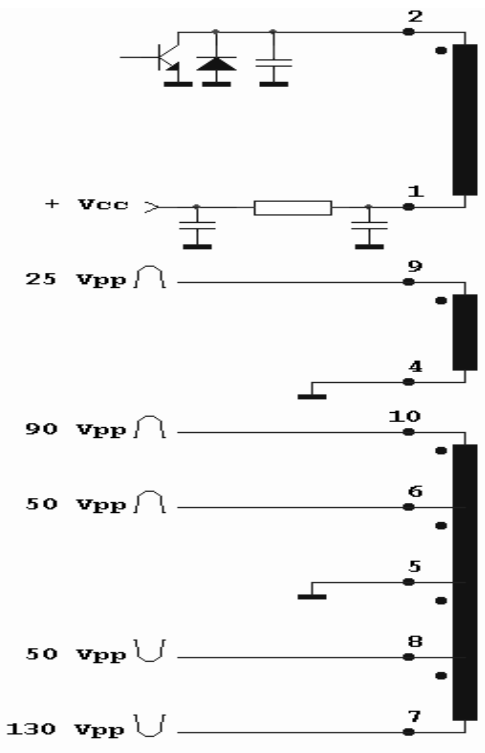

HV	27.2 KV
FV	4.5-9KV
SV	50-1000V

HR8320

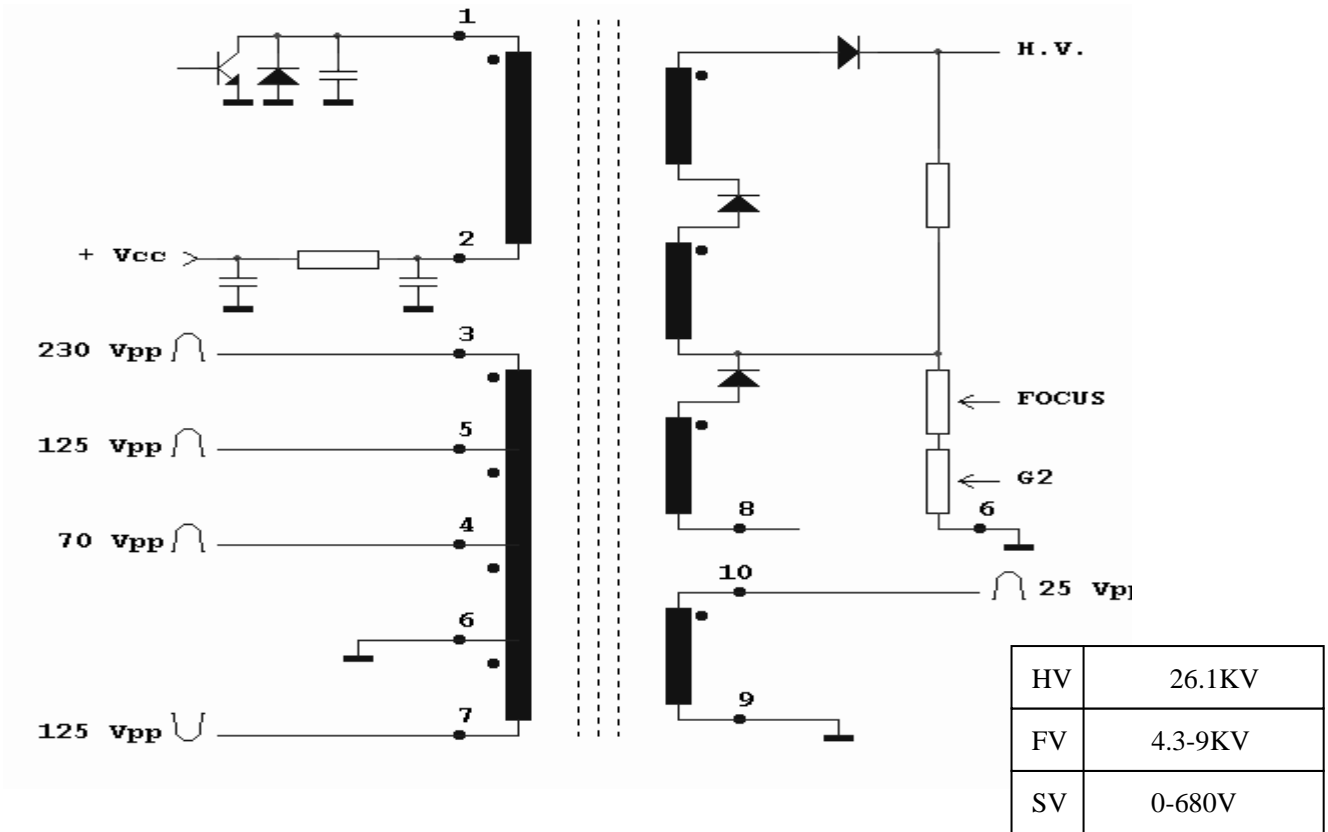

HR8342

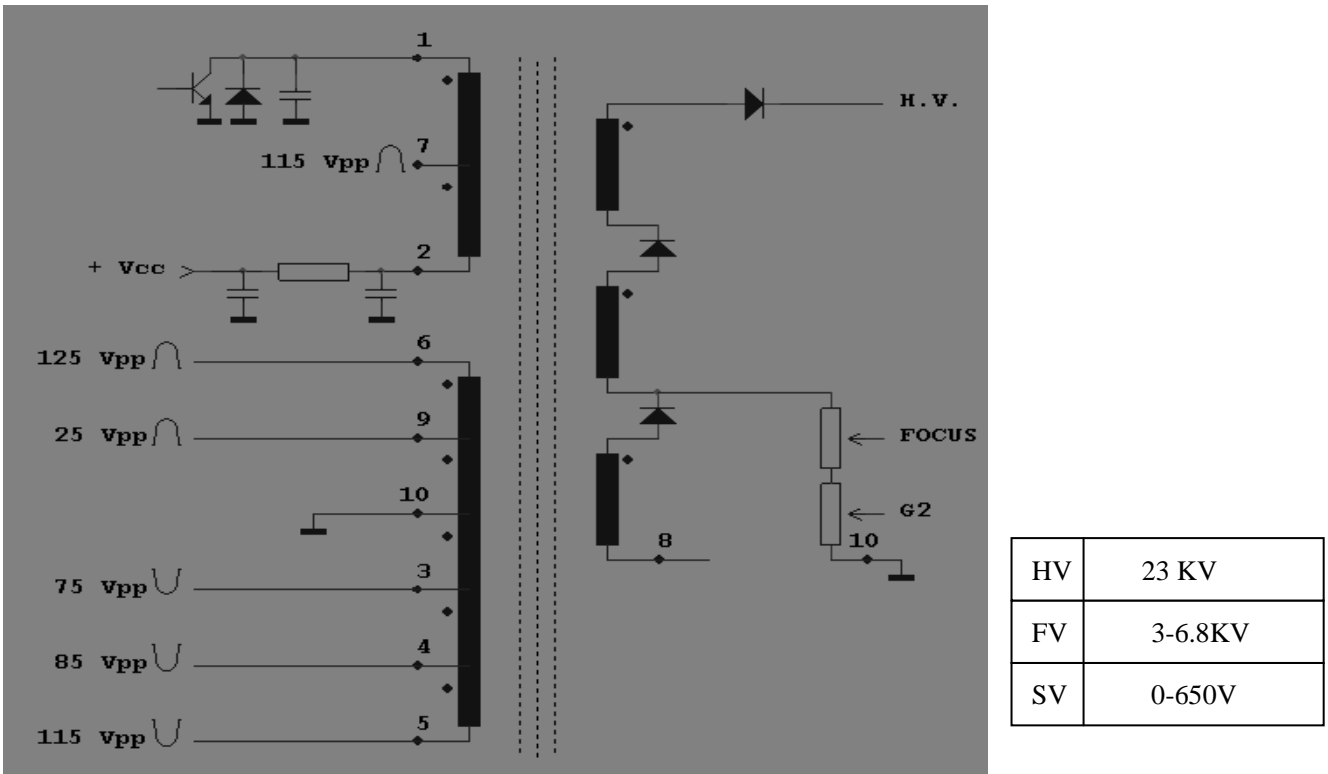

FSA16012M

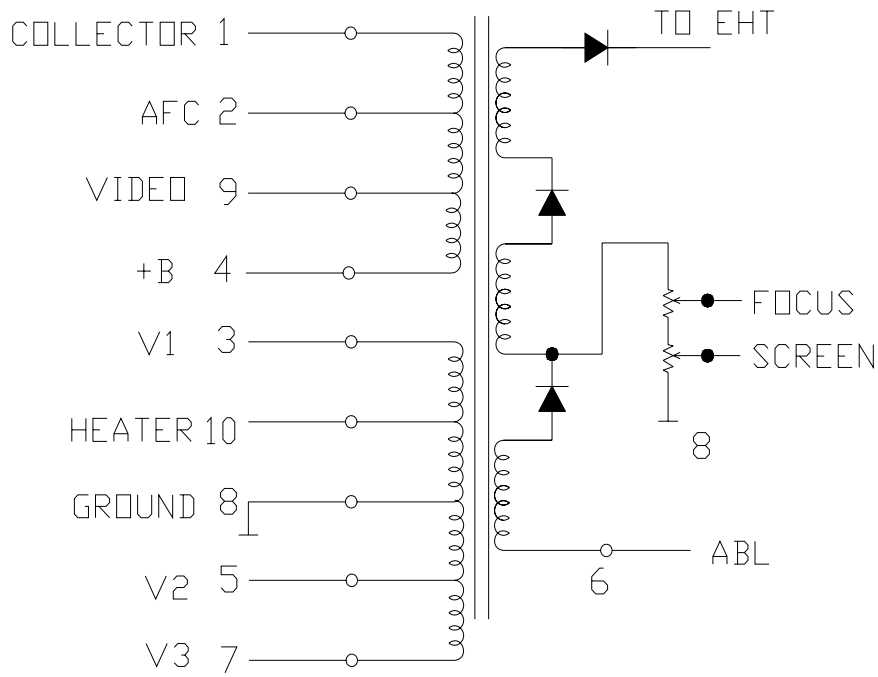

HV	26 KV
FV	4-7.1KV
SV	0-900V

FSA36012M

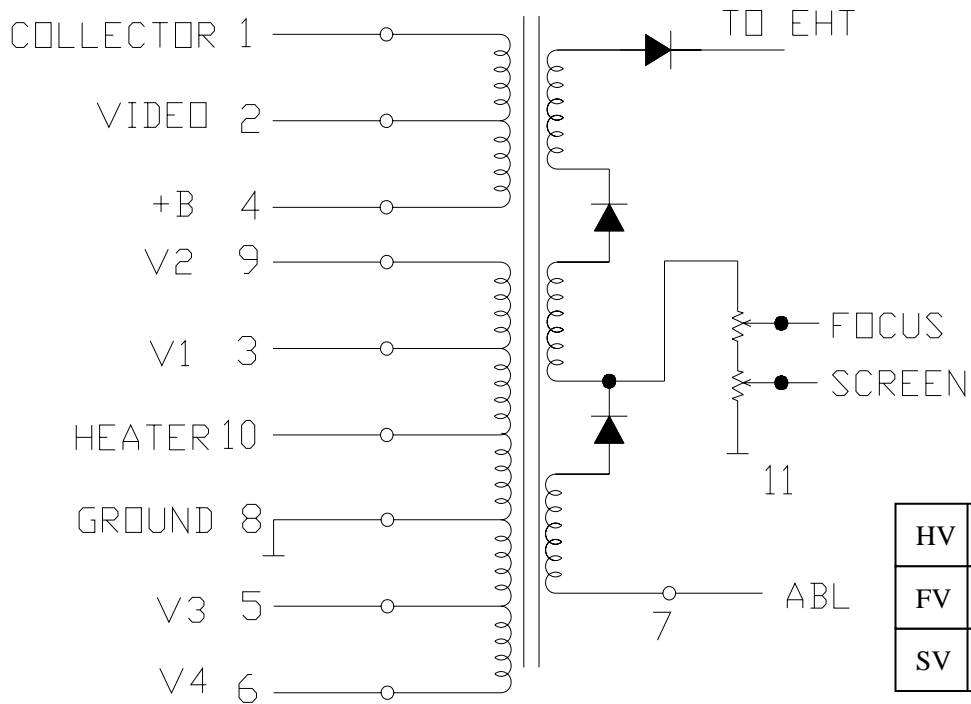

HV	27.1KV
FV	4.9-8KV
SV	5-1020V

FSV14A001

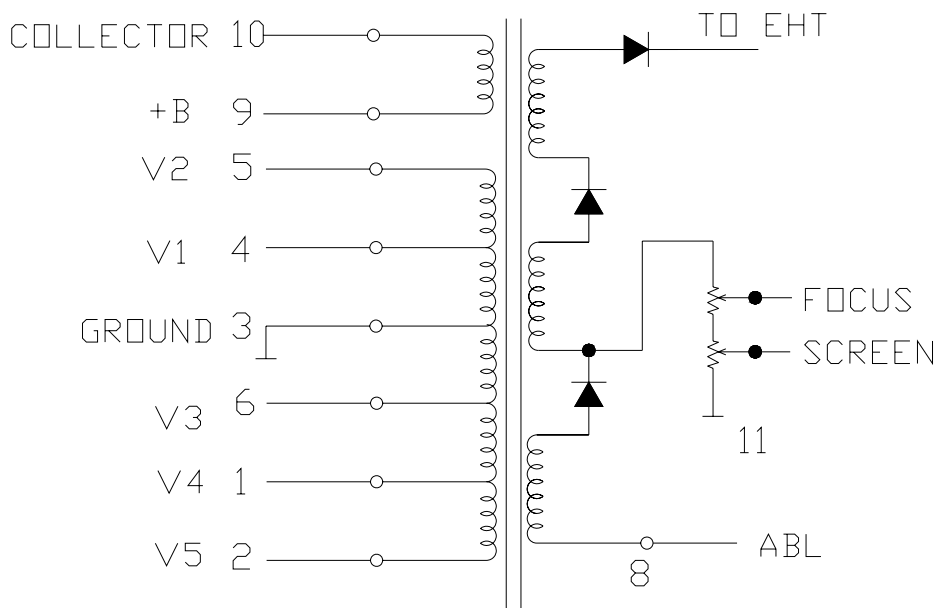

HV	27.1 KV
FV	4.3-8.1KV
SV	0-1250V

FSV14A004

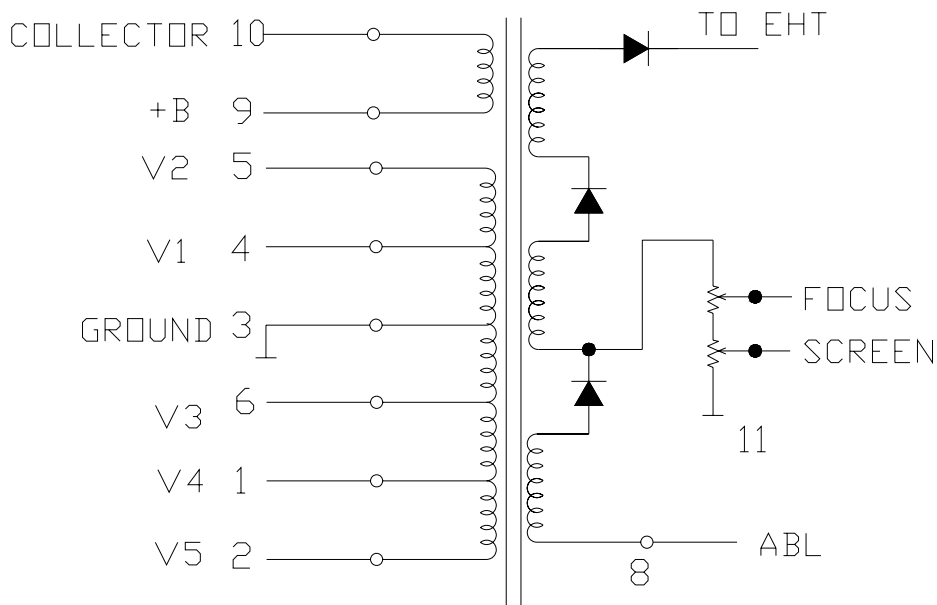

HV	27.3KV
FV	4.9-9.8KV
SV	50-1060V

FSV20A001

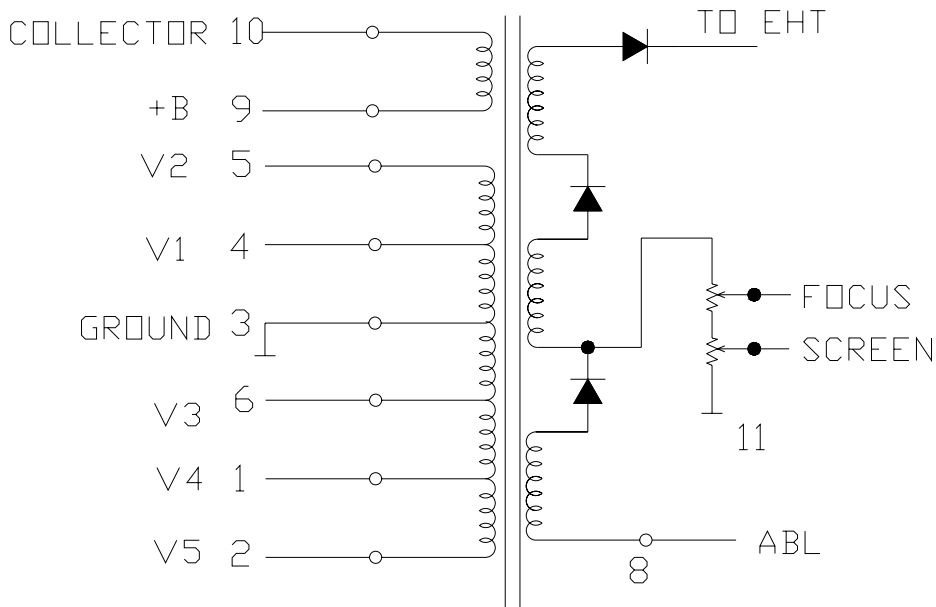

HV	27KV
FV	5.2-10KV
SV	50-860V

PET23-09

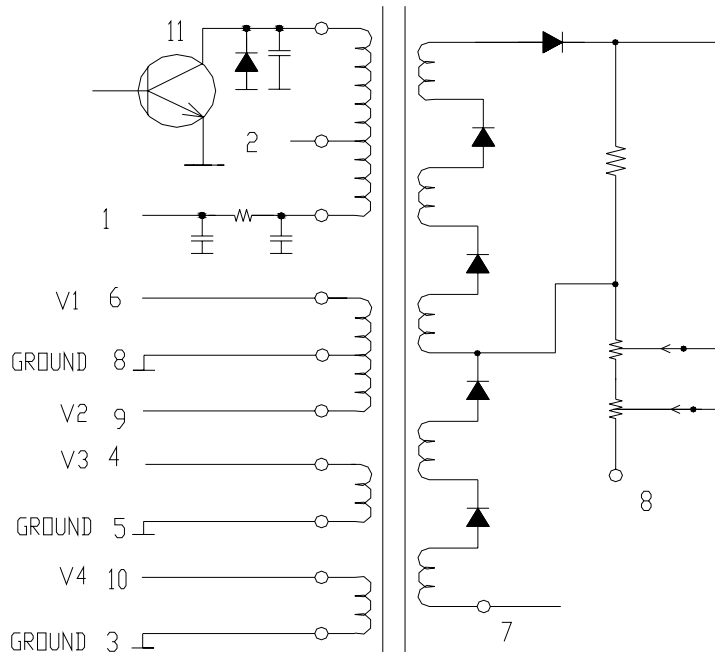

HV	25.9KV
FV	4.3-8.6KV
SV	50-1000V

1142.5086

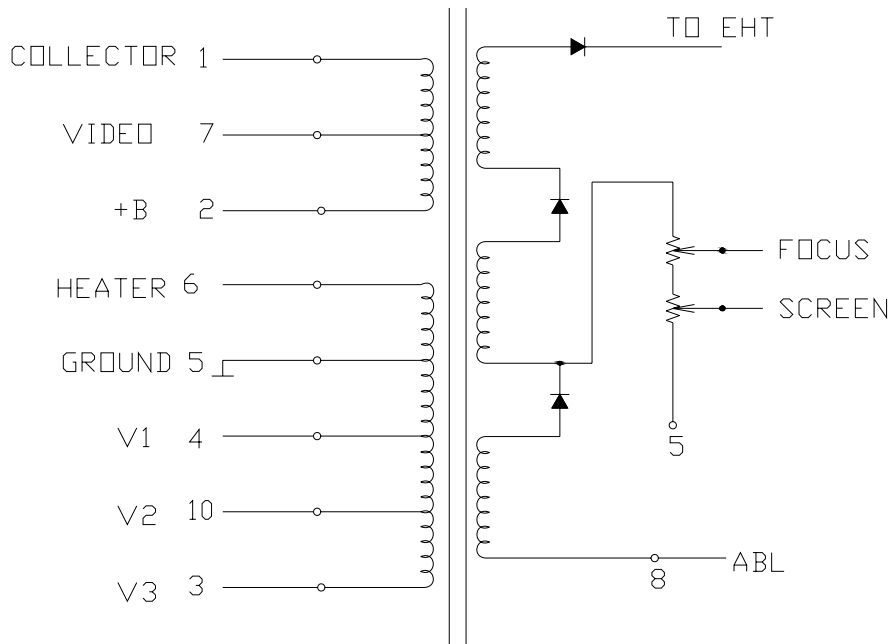

HV	25.1KV
FV	3.5-6.1KV
SV	0-890V

1142.5093

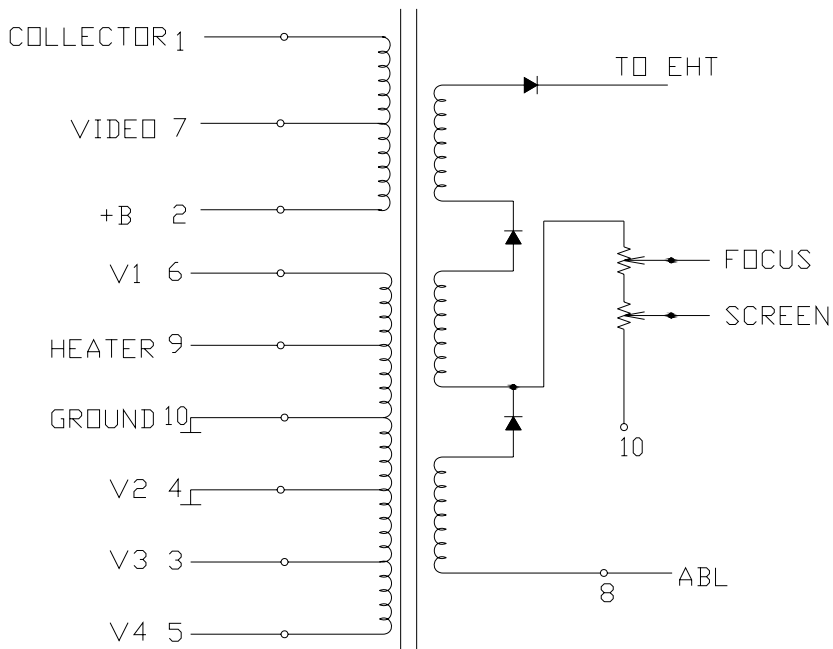

HV	27.6KV
FV	5-9.5KV
SV	100-1100V

1352.5008

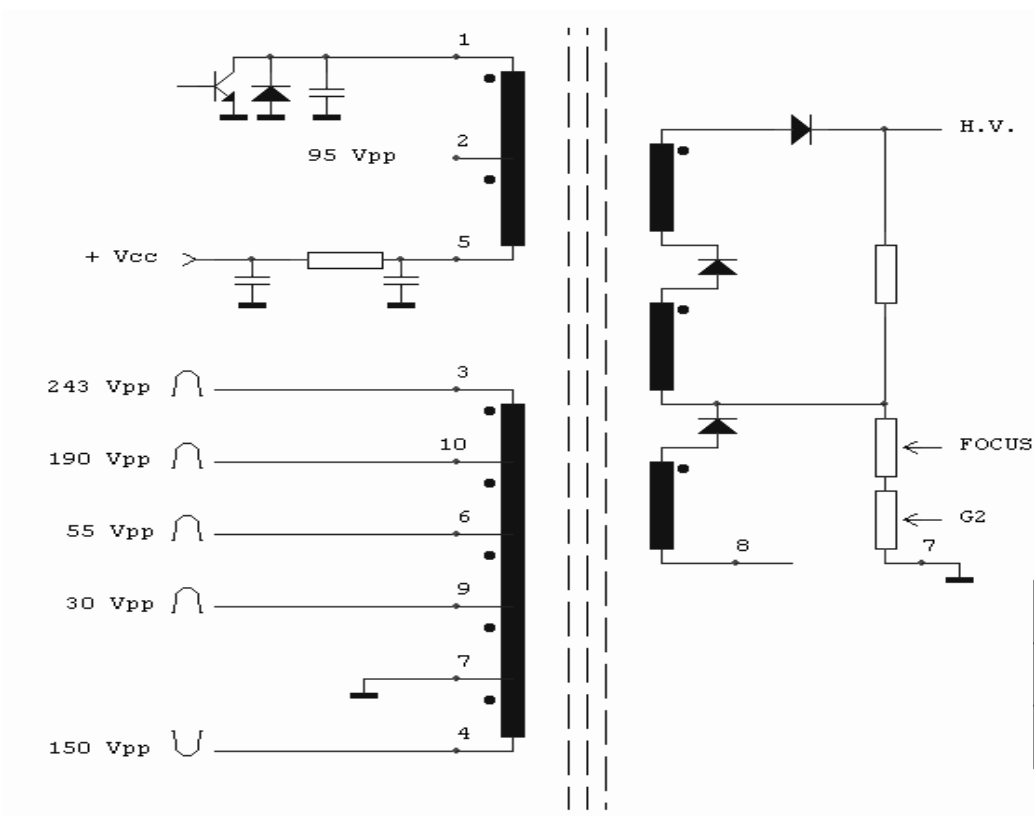

HV	26KV
FV	4-8.2KV
SV	0-900V

1352.5033

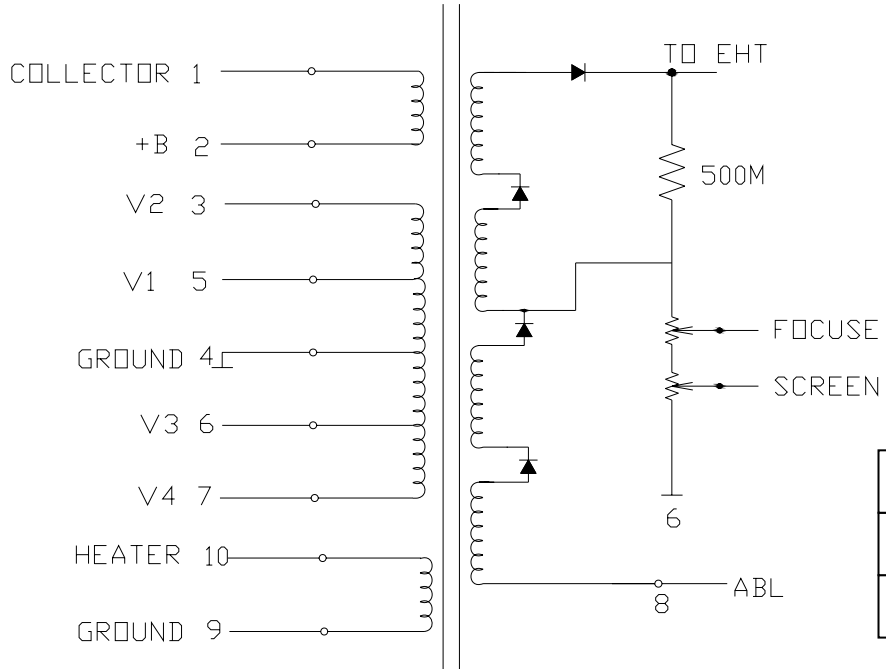

HV	26 KV
FV	4-8.3 KV
SV	0-920V

DCF2077A

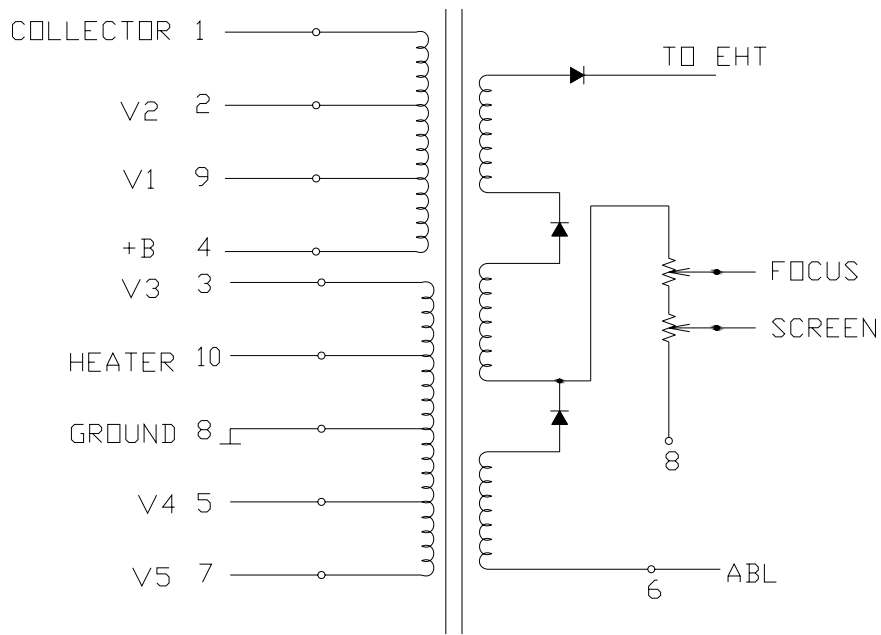

HV	25KV
FV	4-8KV
SV	0-800V

36962

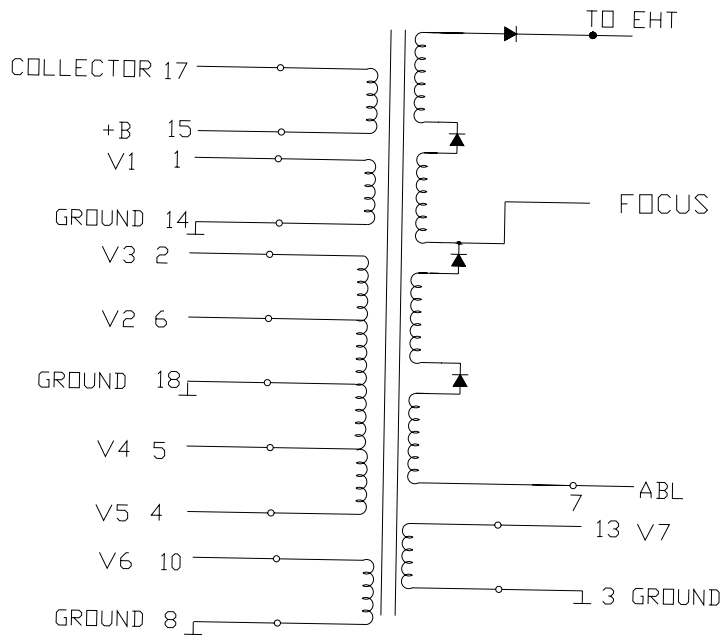

HV	28KV
FV	9.6KV

37622

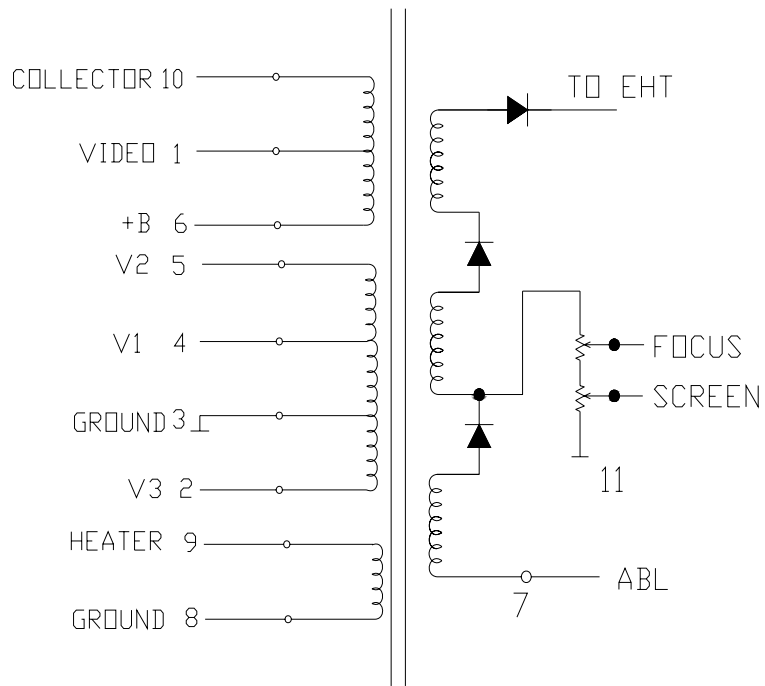

HV	KV
FV	KV
SV	V

AT2077/88E

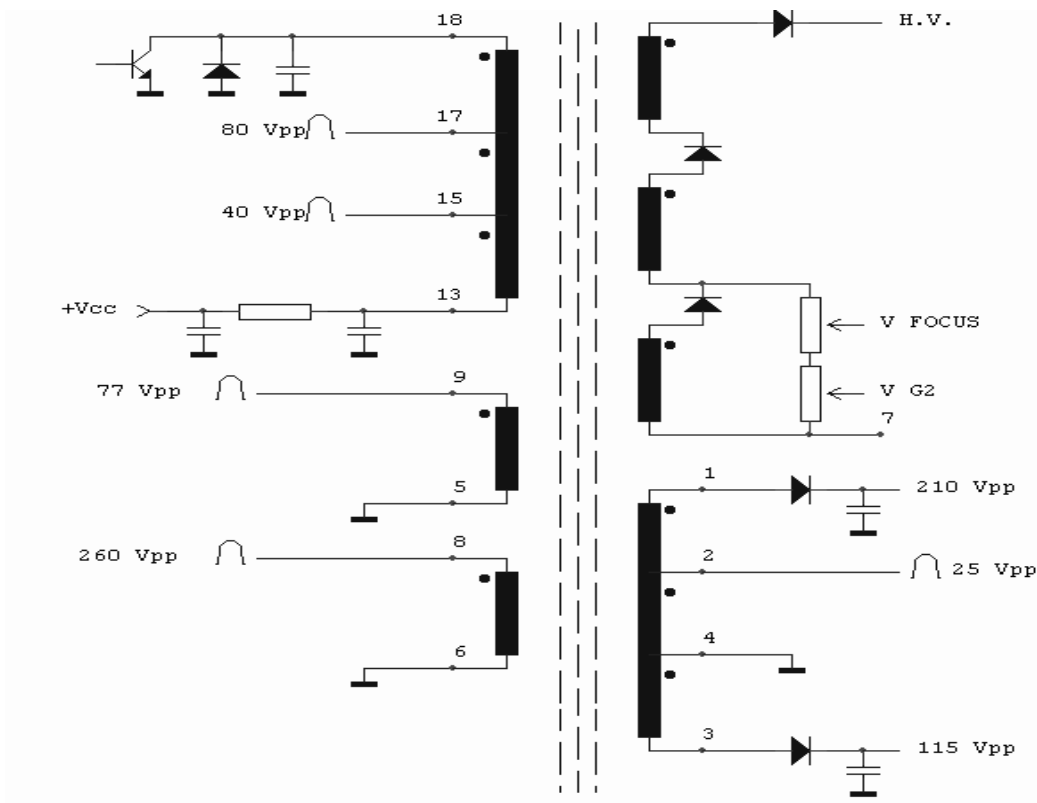

HV	21.5KV
FV	3.9-6.8KV
SV	0-1150V

AT2079/10

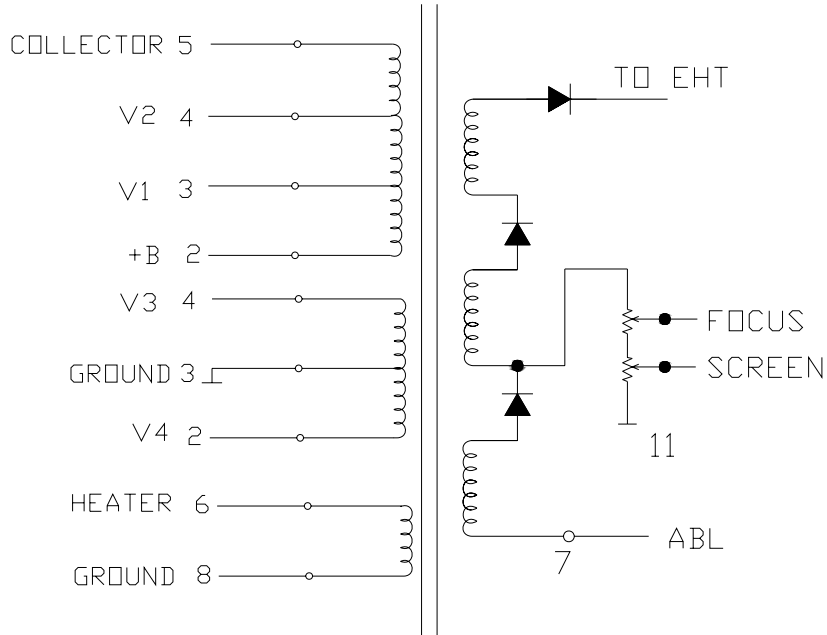

HV	25 KV
FV	3-6KV
SV	0-800V

AT2079/40

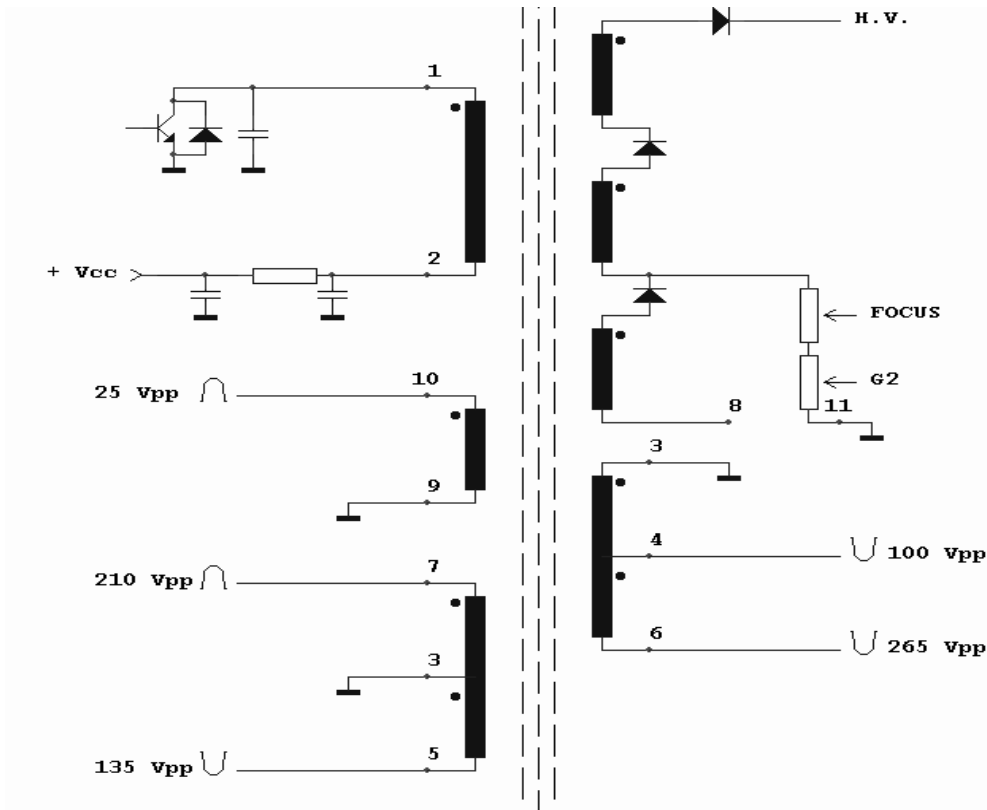

HV	25KV
FV	3.3-6.1KV
SV	0-1015V

AT2079/41

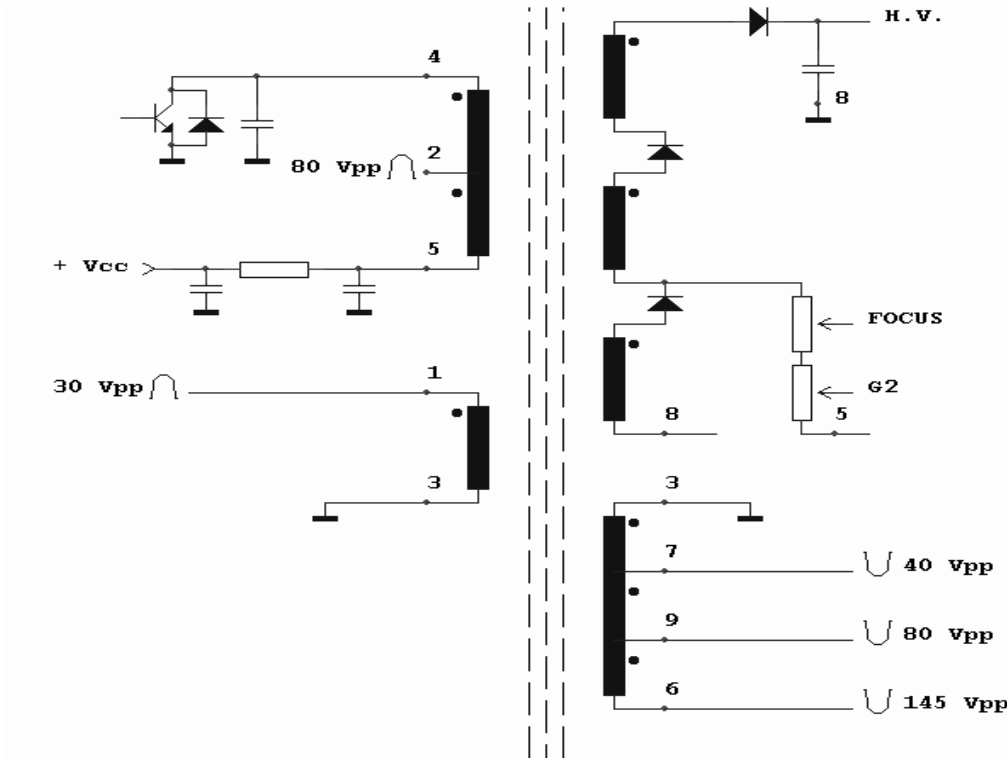

154-064M

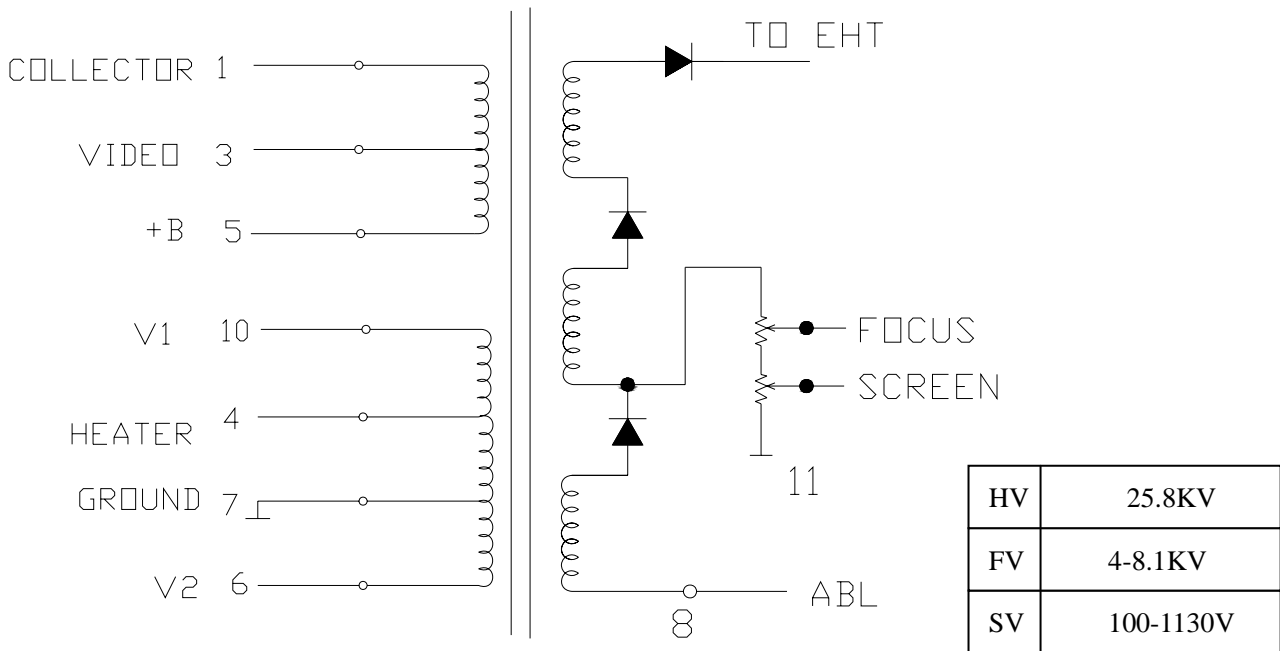

154-064P

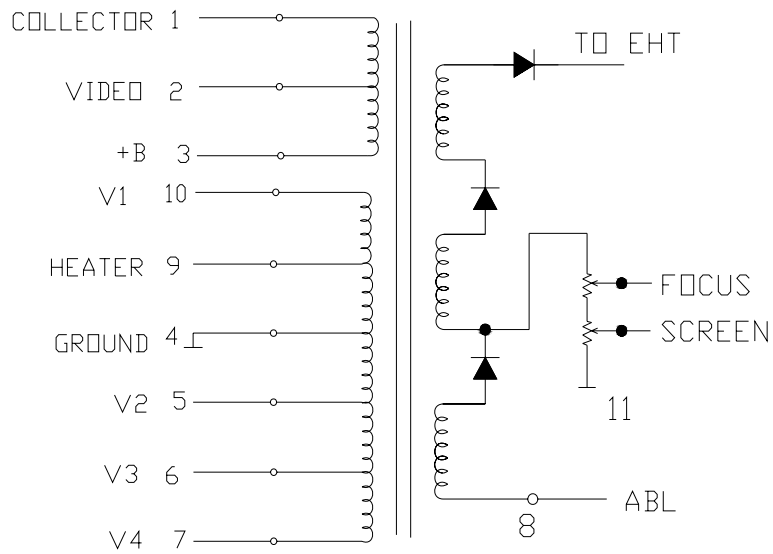

HV	22.5KV
FV	3-6.2KV
SV	0-620V

154-064V

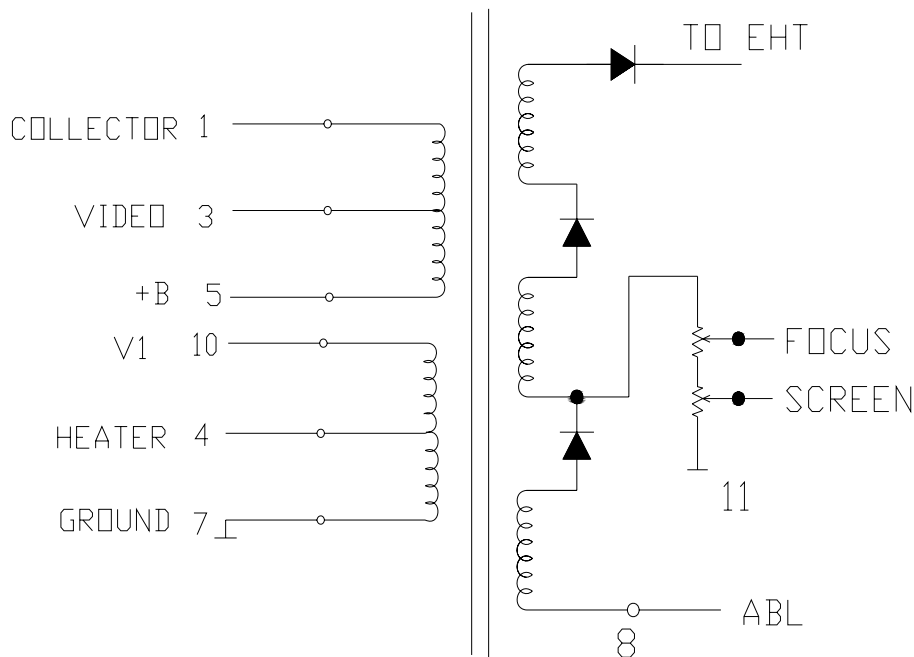

HV	27.1KV
FV	3.9-6.9KV
SV	0-830V

154-177B

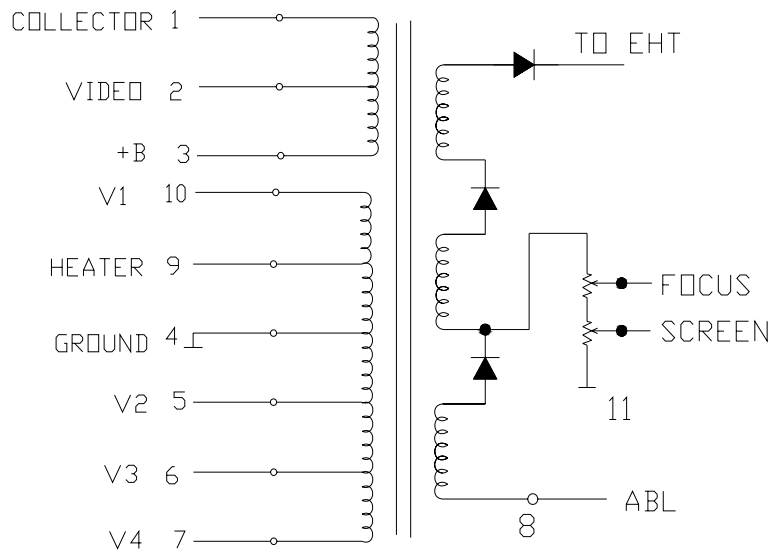

HV	22.6KV
FV	3-6.3KV
SV	0-630V

154-177E

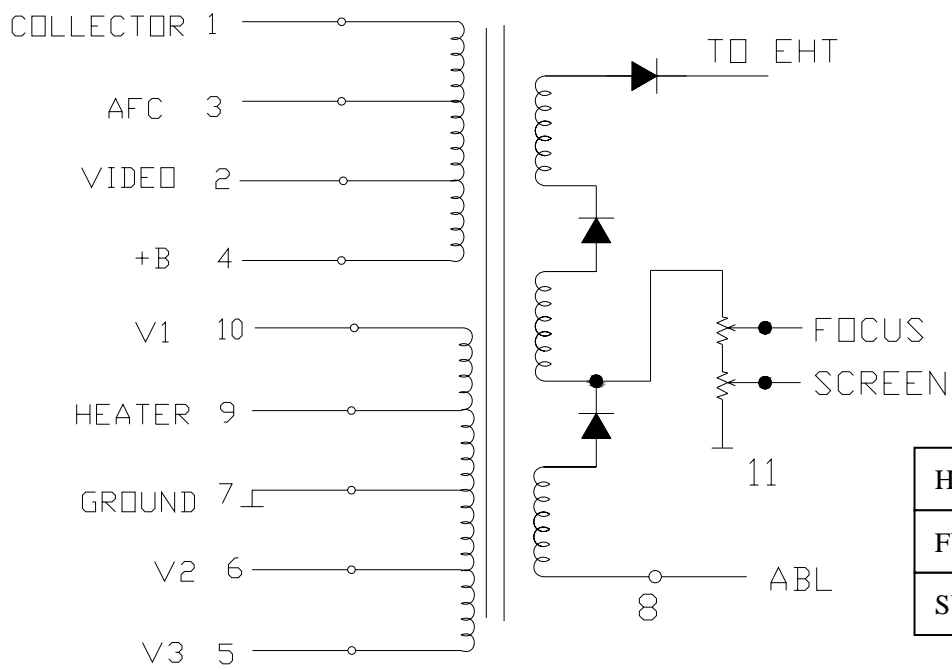

HV	22.3KV
FV	3-6.2KV
SV	0-580V

154-194B

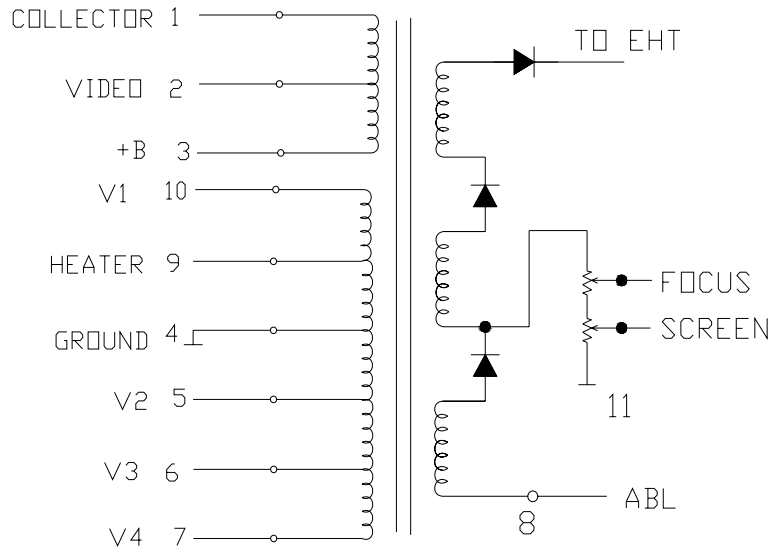

HV	28KV
FV	4-9.9KV
SV	200-1200V

154-194D

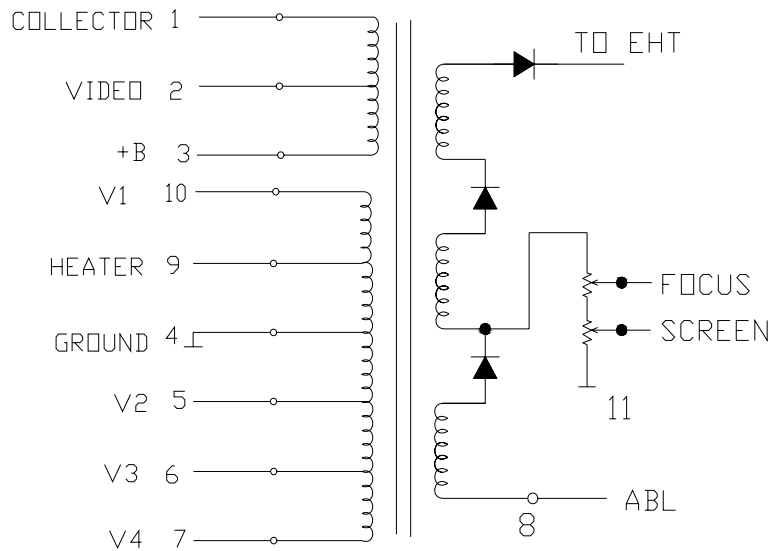

HV	26 KV
FV	4-8 KV
SV	0-650V

154-277C

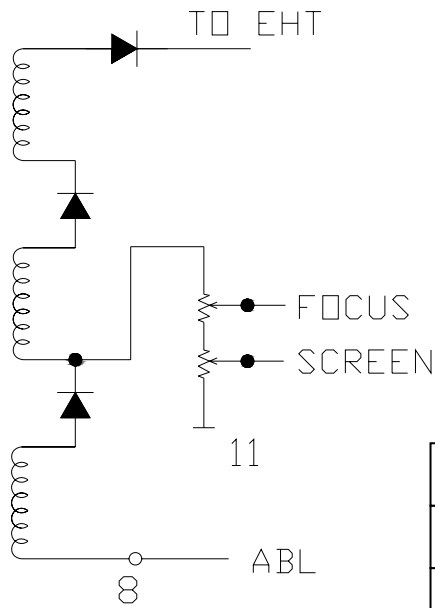
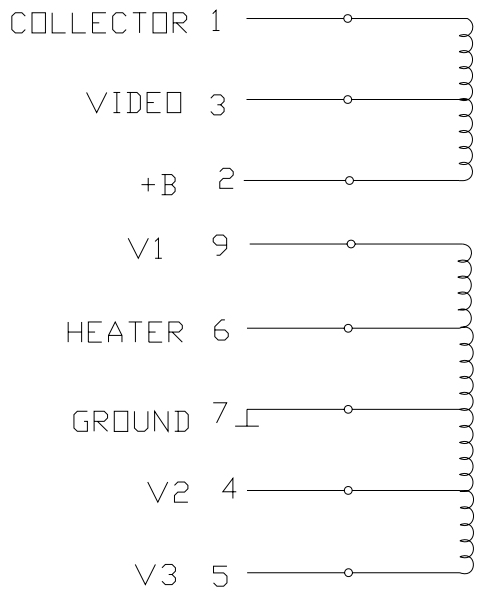

HV	23 KV
FV	3-6.5KV
SV	2-560V

154-375F

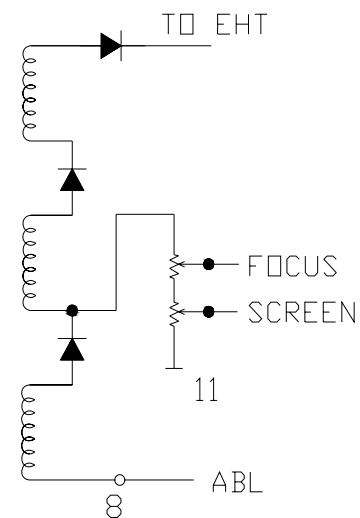
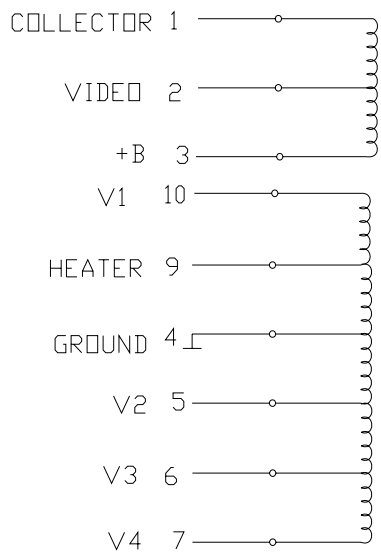

HV	26.4 KV
FV	3.9-8.1KV
SV	40-980V

FCK20B003

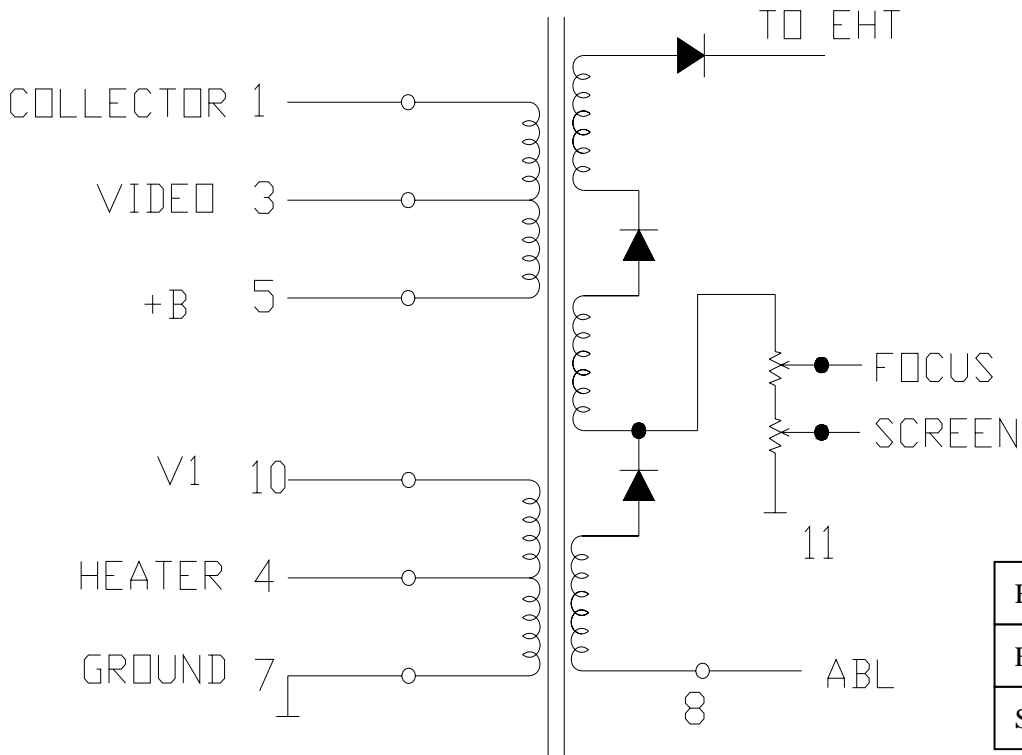

HV	23.9 KV
FV	4.1-6.9KV
SV	0-500V

FCM1415AL

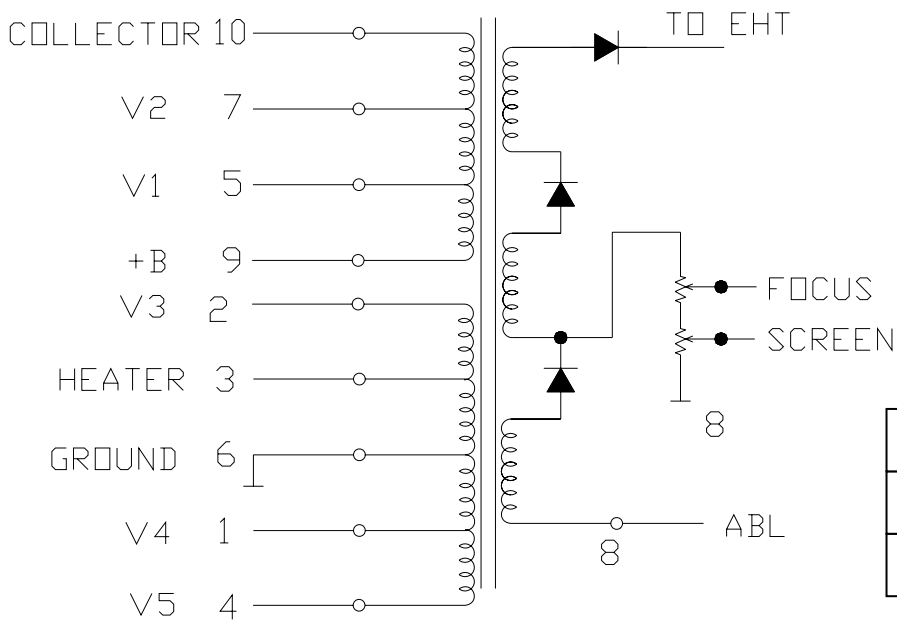

HV	23.5 KV
FV	3-5.7KV
SV	55-750V

FCM2015AL

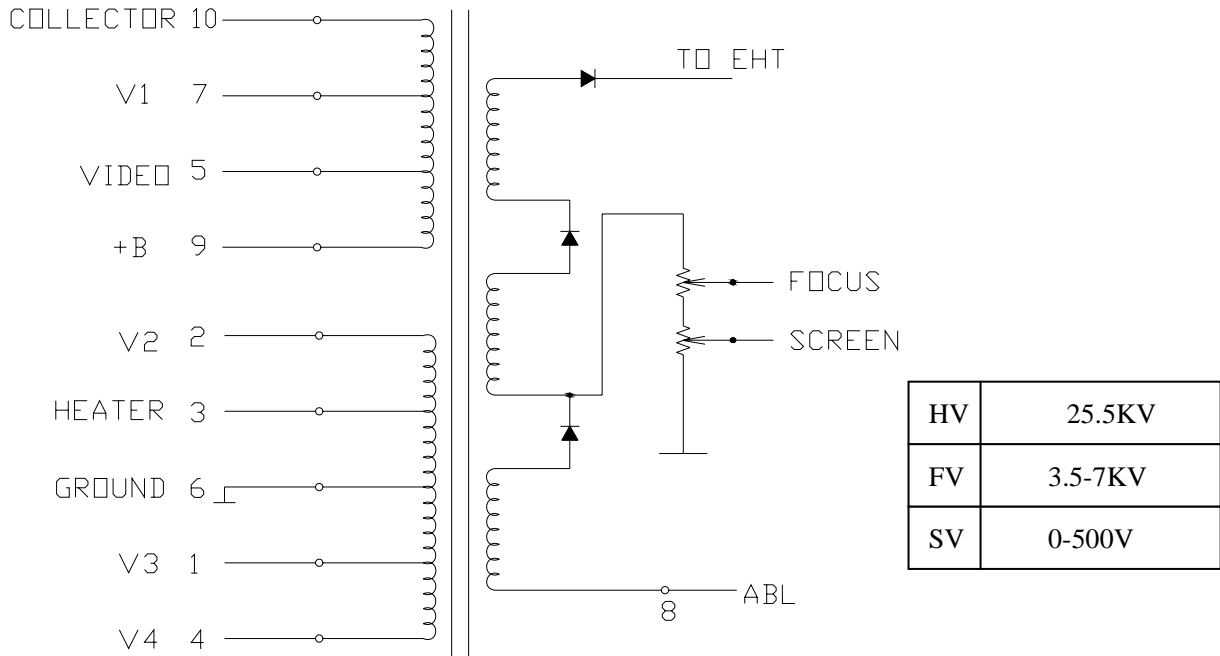

FCM20B027

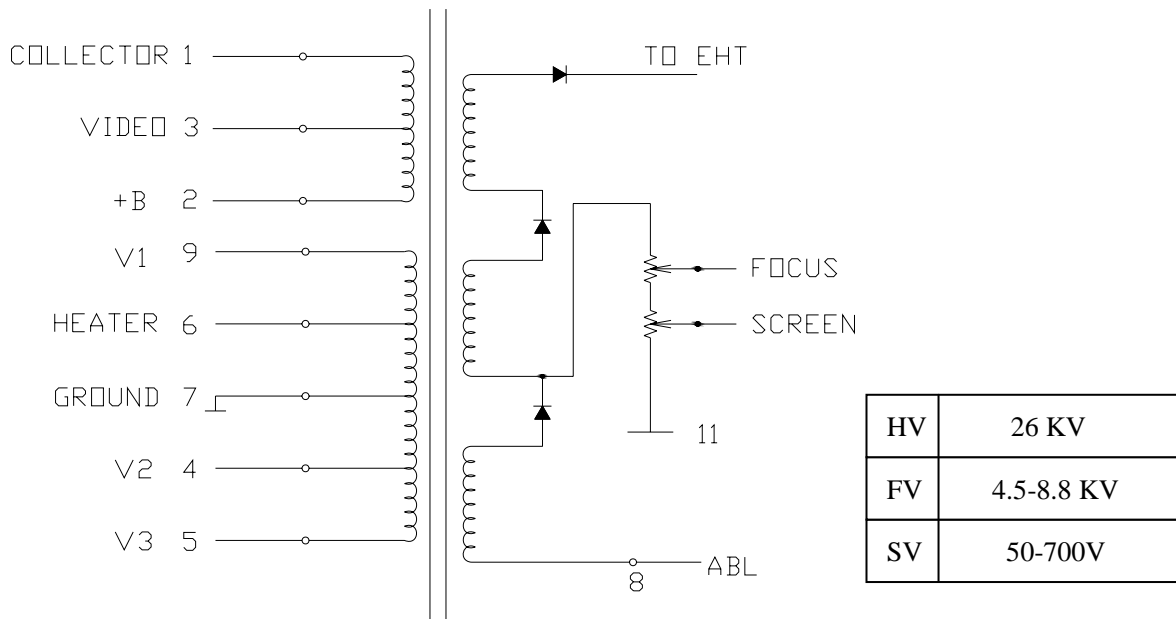

FCM2211E01

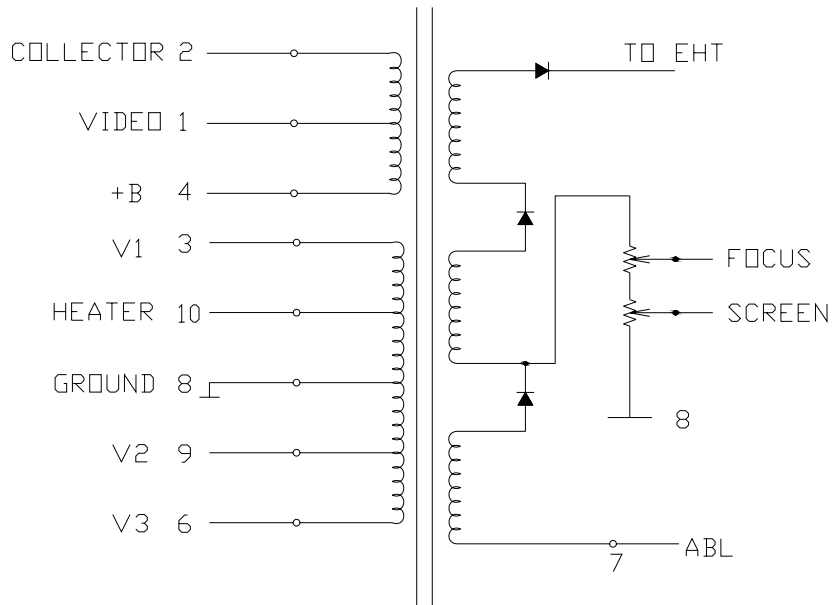

HV	25KV
FV	4-8KV
SV	0-700V

FCR25A001

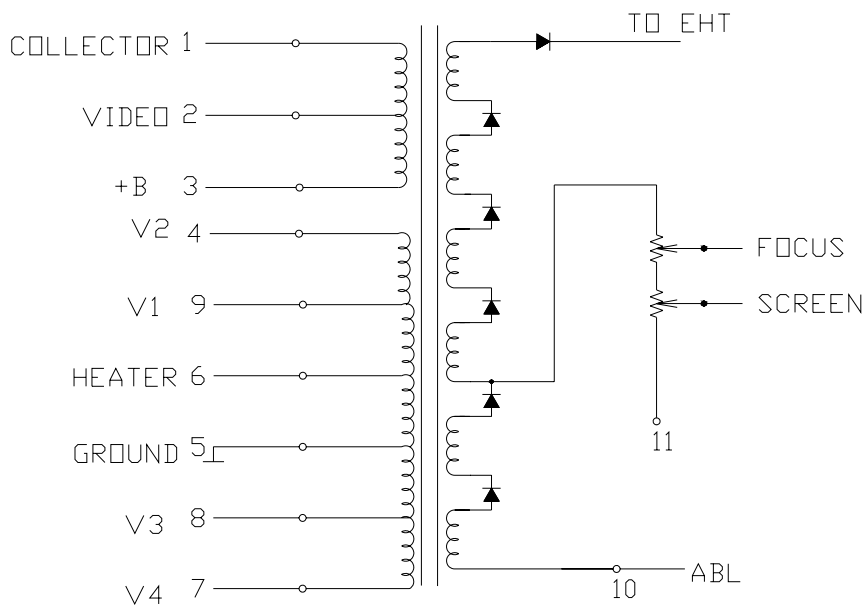

HV	28KV
FV	4.5-8.7KV
SV	50-700V

FCV1422L01

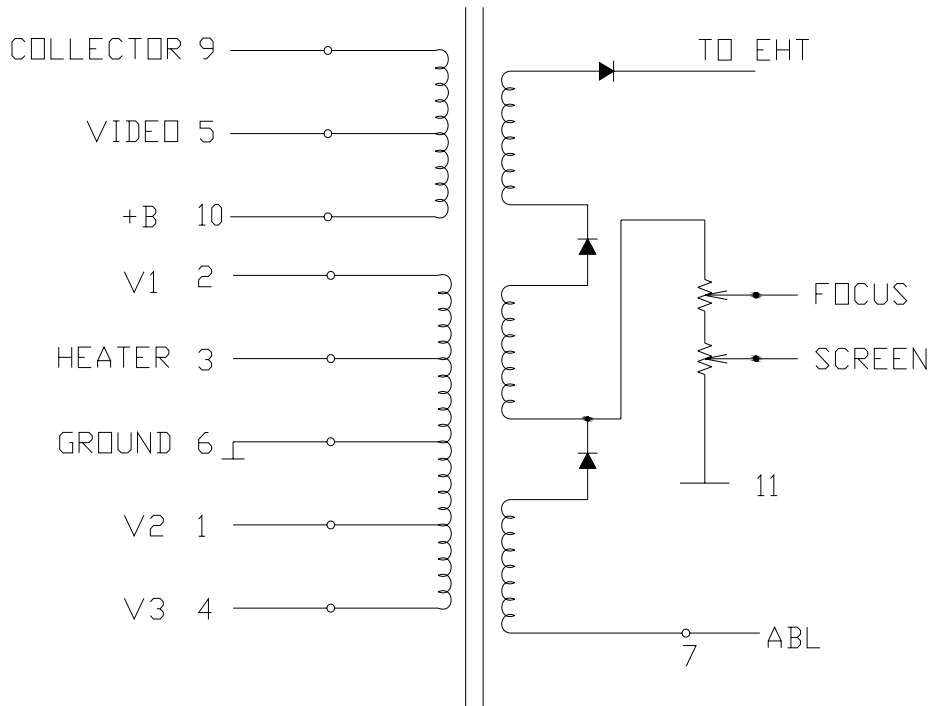

HV	27.2KV
FV	4.1-8.1KV
SV	5-1000V

FCV20A001

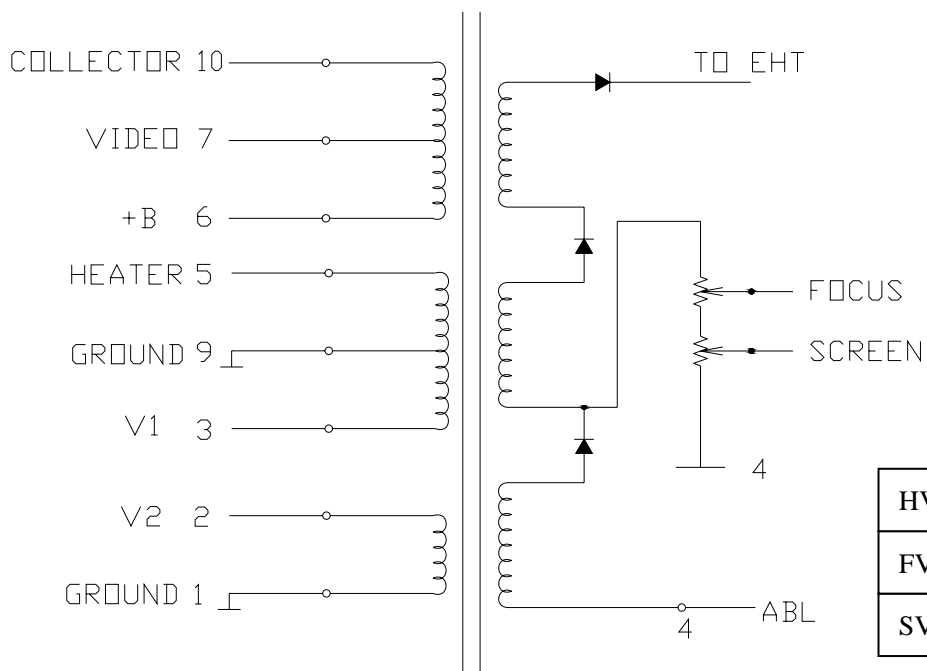

HV	24.9KV
FV	4.2-7.8KV
SV	0-720V

BSC22-01N40G1

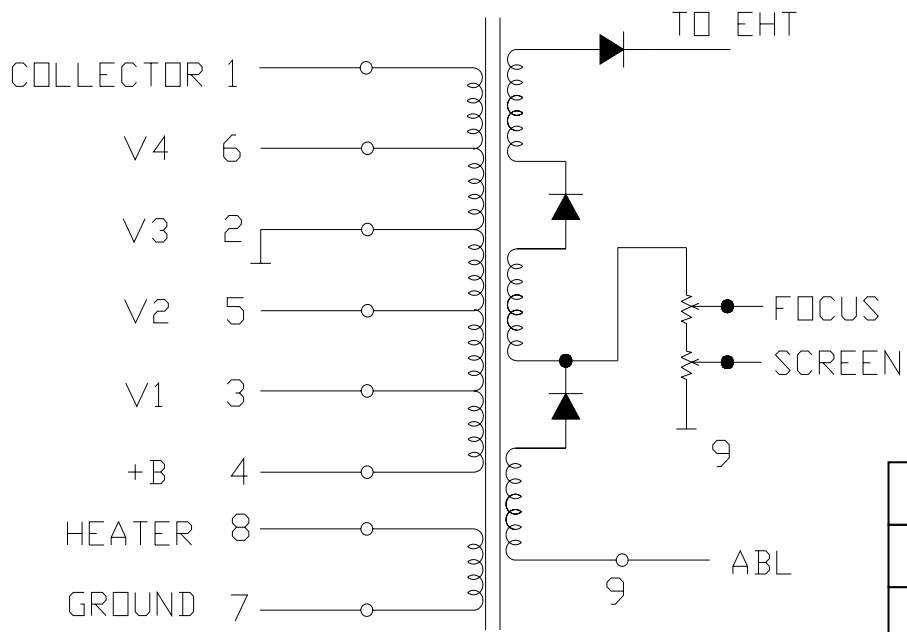

BSC2203

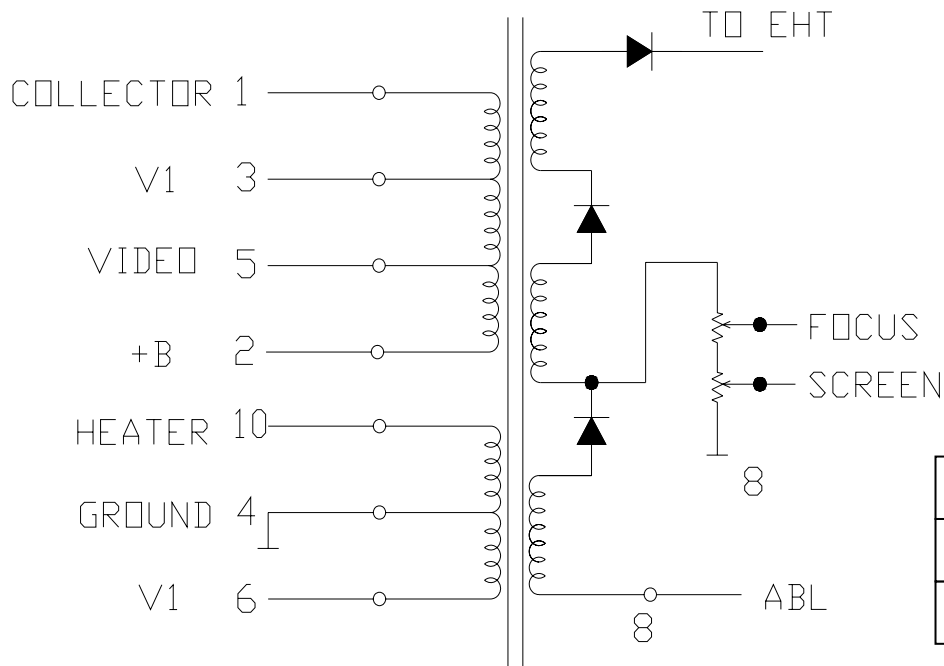

BSC2206

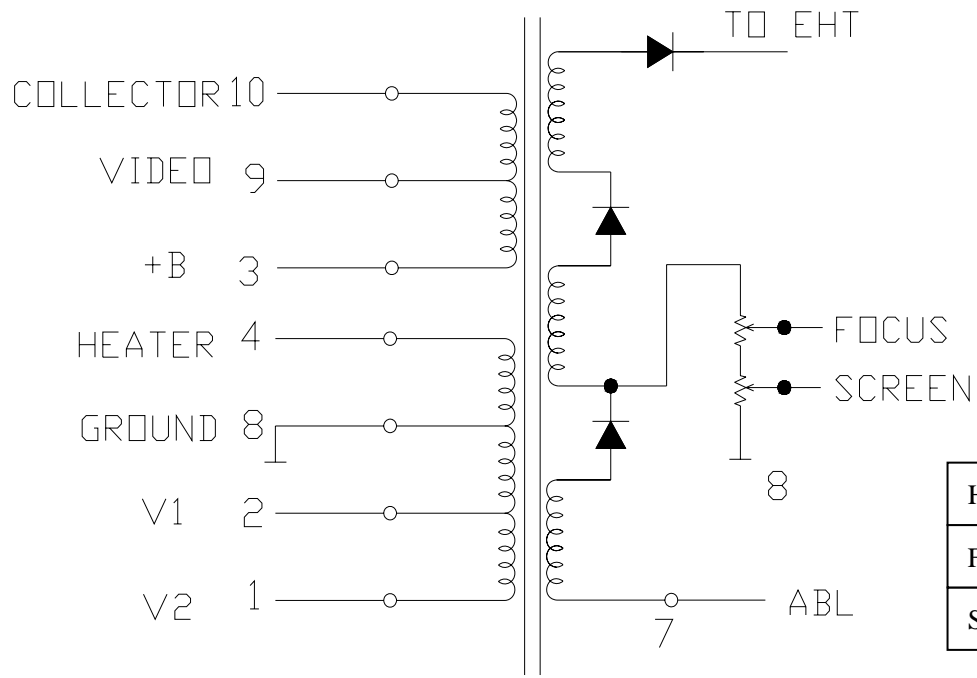

HV	25.2 KV
FV	4-8.2KV
SV	0-700V